



# Crossover

## Water Heaters

**Installation**

**Start-Up**

**Maintenance**

**Parts**

**Warranty**

**RGH-150 / 199\* Models**

\*"LP" Denotes Propane Gas



### **! DANGER**

This manual must only be used by a qualified installer / service technician. Read all instructions in this manual before installing. Perform steps in the given order. Failure to do so could result in substantial property damage, severe personal injury, or death.

### **! WARNING**

Improper installation, adjustment, alteration, service, or maintenance could void product warranty and cause property damage, severe personal injury, or death.

California Proposition 65 Warning: This product contains chemicals known to the State of California to cause cancer, birth defects, or other reproductive harm.

### **NOTICE**

The manufacturer reserves the right to make product changes or updates without notice and will not be held liable for typographical errors in literature.

The surfaces of these products contacted by potable (consumable) water contain less than 0.25% lead by weight as required by the Safe Drinking Water Act, Section 1417.

**NOTE TO CONSUMER: PLEASE KEEP ALL INSTRUCTIONS FOR FUTURE REFERENCE.**

## **WARNING**

**WARNING:** If the information in these instructions is not followed exactly, a fire or explosion may result causing property damage, personal injury or death.

- Do not store or use gasoline or other flammable vapors and liquids in the vicinity of this or any other appliance.

### **WHAT TO DO IF YOU SMELL GAS**

- Do not try to light any appliance.
- Do not touch any electrical switch; do not use any phone in your building.
- Immediately call your gas supplier from a neighbor's phone. Follow the gas supplier's instructions.
- If you cannot reach your gas supplier, call the fire department.
- Installation and service must be provided by a qualified installer, service agency or the gas supplier.



**Improper installation, adjustment, alteration, service, or maintenance can cause injury, property damage, or death. Refer to this manual. Installation and service must be performed by a qualified installer, service agency, or gas supplier.**

## **FOR YOUR SAFETY READ BEFORE OPERATING**

 **WARNING :** If you do not follow these instructions exactly, a fire or explosion may result causing property damage, personal injury or loss of life."

- A. This appliance does not have a pilot. It is equipped with an ignition device which automatically lights the burner. Do not try to light the burner by hand.
- B. **BEFORE OPERATING** smell all around the appliance area for gas. Be sure to smell next to the floor because some gas is heavier than air and will settle on the floor.
- WHAT TO DO IF YOU SMELL GAS**
- Do not touch any electric switch; do not use any phone in your building.
  - Do not try to light any appliance.
  - Immediately call your gas supplier from a neighbor's phone. Follow the gas supplier's instructions.
  - If you cannot reach your gas supplier, call the fire department.
- C. Use only your hand to push in or turn the gas control knob. Never use tools. If the knob will not push in or turn by hand, don't try to repair it, call a qualified technician. Force or attempted repair may result in a fire or explosion.
- D. Do not use this appliance if any part has been under water. Immediately call a qualified technician to inspect the appliance and to replace any part of the control system and any gas control which has been under water.

## **OPERATING INSTRUCTIONS**

1. **STOP!** Read the safety information above on this label.
2. Set the thermostat to lowest setting.  
(Never use Water Heater unless it is completely filled with water.)
3. Turn **OFF** electrical power supply to the Water Heater.
4. Don't try to light the burner by hand.
5. Turn gas shut-off valve clockwise  to "OFF" position. Do not force.
6. Wait five (5) minutes to clear out any gas. If you then smell gas, **STOP!** Follow step "B" above on this label. If you don't smell gas, go to the next step.
7. Turn manual gas shut-off valve counterclockwise  to "ON" position.
8. Turn **ON** electrical power to the appliance.
9. Wait until default temperature (125°F) is displayed. Set desired water temperature. Turn on hot water faucet.
10. Set thermostat to desired setting.
11. If the appliance will not operate, follow the instructions "To Turn Off Gas To Appliance" and call your service technician or gas supplier.

## **TO TURN OFF GAS TO APPLIANCE**

1. Set the thermostat to lowest setting.
2. Turn off all electric power to the appliance if service is to be performed.
3. Turn manual gas shutoff valve to "OFF".

### **SPECIAL ATTENTION BOXES**

The following defined terms are used throughout this manual to bring attention to the presence of hazards of various risk levels or to important product information.

#### **DANGER**

**DANGER** indicates an imminently hazardous situation which, if not avoided, will result in serious personal injury or death.

#### **WARNING**

**WARNING** indicates a potentially hazardous situation which, if not avoided, could result in personal injury or death.

#### **CAUTION**

**CAUTION** indicates a potentially hazardous situation which, if not avoided, may result in moderate or minor personal injury.

#### **CAUTION**

**CAUTION used without the safety alert symbol** indicates a potentially hazardous situation which, if not avoided, may result in property damage.

#### **NOTICE**

**NOTICE** is used to address practices not related to personal injury.

## Foreword

This manual is intended to be used in conjunction with other literature provided with the water heater. This includes all related control information. It is important that this manual, all other documents included in this system, and additional publications including the *National Fuel Gas Code - ANSI Z223.1* (latest versions), be reviewed in their entirety before beginning any work.

Installation should be made in accordance with the regulations of the Authority Having Jurisdiction, local code authorities, and utility companies which pertain to this type of water heating equipment.

Authority Having Jurisdiction (AHJ) – The AHJ may be a federal, state, local government, or individual such as a fire chief, fire marshal, chief of a fire prevention bureau, labor department or health department, building official or electrical inspector, or others having statutory authority. In some circumstances, the property owner or his/her agent assumes the role, and at government installations, the commanding officer or departmental official may be the AHJ.

**NOTE:** The manufacturer reserves the right to modify product technical specifications and components without prior notice.

## For the Installer

This water heater must be installed by qualified and licensed personnel. The installer should be guided by the instructions furnished with the water heater, and by local codes and utility company requirements. In the absence of local codes, preference should be given to the *National Fuel Gas Code - ANSI Z223.1*, latest version.

### Installations Must Comply With:

Local, state, provincial, and national codes, laws, regulations, and ordinances.

The latest version of the *National Fuel Gas Code, ANSI Z223.1*, from American Gas Association Laboratories, 8501 East Pleasant Valley Road, Cleveland, OH 44131.

In Canada - *CGA No. B149* (latest version), from Canadian Gas Association Laboratories, 55 Scarsdale Road, Don Mills, Ontario, Canada M3B 2R3. Also, *Canadian Electrical Code, C 22.1*, from Canadian Standards Association, 5060 Spectrum Way, Suite 100, Mississauga, Ontario, Canada L4W 5N6.

The latest version of the *National Electrical Code, NFPA No. 70*.

**NOTE:** The gas manifold and controls met safe lighting and other performance criteria when undergoing tests specified in *ANSI Z21.10.3* - latest edition.

**⚠ DANGER**

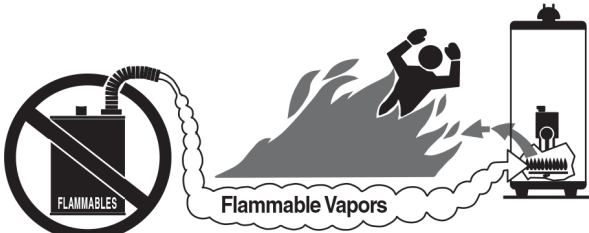

**⚠ Vapors from flammable liquids will explode and catch fire causing death or severe burns.**  
Do not use or store flammable products such as gasoline, solvents or adhesives in the same room or area near the water heater.  
Keep flammable products:  
1. far away from heater,  
2. in approved containers,  
3. tightly closed and  
4. out of children's reach.

Water heater has a main burner and pilot flame.  
The pilot flame:  
1. which can come on at any time and  
2. will ignite flammable vapors.  
Vapors:  
1. cannot be seen,  
2. are heavier than air,  
3. go a long way on the floor and  
4. can be carried from other rooms to the pilot flame by air currents.

**Installation:**  
Do not install water heater where flammable products will be stored or used unless the main burner and pilot flames are at least 18" above the floor. This will reduce, but not eliminate, the risk of vapors being ignited by the main burner or pilot flame.

Read and follow water heater warnings and instructions. If owners manual is missing, contact the retailer or manufacturer.

**⚠ DANGER**

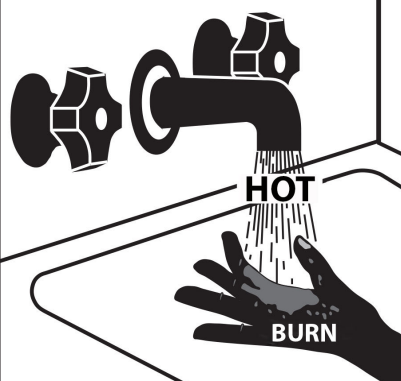

Water temperature over 125°F can cause severe burns instantly or death from scalds. Children, disabled and elderly are at highest risk of being scalded. See instruction manual before setting temperature at water heater. Feel water before bathing or showering. Temperature limiting valves are available, see manual.

## **WARNING**

### **From the Uniform Plumbing Code 2000 - Section 510 - Protection From Damage**

1. Water heaters generating a glow, spark or flame capable of igniting flammable vapors may be installed in a garage, provided the pilots, burners or heating elements and switches are at least eighteen (18) inches (457 mm) above the floor level.
2. Where such water heaters installed within a garage are enclosed in a separate, approved compartment having access only from outside of the garage, such water heaters may be installed at floor level provided the required combustion air is also taken from the exterior of the garage. Fuel burning water heaters having sealed combustion chambers need not be elevated.
3. All water heaters installed in areas where they may be subjected to mechanical damage shall be suitably guarded against such damage by being installed behind adequate barriers or by being elevated or located out of the normal path of a vehicle using any such garage.
4. In seismic zones 3 and 4, water heaters shall be anchored or strapped to resist horizontal displacement due to earthquake motion. Strapping shall be at points within the upper one-third (1/3) and lower one-third (1/3) of its vertical dimensions. At the lower point, a minimum distance of four (4) inches (102 mm) shall be maintained above the controls with the strapping.
5. An water heater supported from the ground shall rest on level concrete or other approved base extending not less than three (3) inches (76 mm) above the adjoining ground level.
6. When an water heater is located in an attic, attic-ceiling assembly, floor-ceiling assembly, or floor-subfloor assembly where damage may result from a leaking water heater, a watertight pan of corrosion resistant materials shall be installed beneath the water heater with a minimum three-quarter (3/4) inch (20 mm) diameter drain to an approved location.

#### **Table of Contents**

<b>Part 1 - General Safety Information</b>	<b>5</b>	<b>E. Applications</b>	18
A. Operation and Installation Warnings	5	<b>F. Circulator Sizing</b>	26
B. Improper Combustion	6	<b>G. Pressure Relief Valve</b>	27
C. Gas	6	<b>H. Filling the Heater</b>	28
D. When Servicing the Water Heating System	6	<b>Part 5 - Venting</b>	<b>28</b>
E. Water Chemistry Requirements	6	A. General	28
F. Freeze Protection	7	B. Approved Materials for Exhaust Vent and Intake Pipe	29
G. Water Temperature Adjustment and Scalding	7	C. Additional Requirements for Installation in Canada	30
H. High Elevation Installations	7	D. Exhaust Vent and Intake Pipe Location	31
<b>Part 2 - Before You Start</b>	<b>8</b>	E. Exhaust Vent and Intake Pipe Sizing	32
A. What's in the Box	8	F. Tightening Water Heater Collar to Exhaust Vent and Intake Pipe	32
B. Optional Equipment	8	G. Exhaust Vent and Intake Pipe Installation	32
<b>Part 3 - Prepare the Water Heater Installation</b>	<b>9</b>	H. Applications	33
A. Locating the Water Heater	9	1. Direct Vent Installation of Exhaust and Intake	33
B. Leveling	10	2. Venting Through an Existing System	36
C. Clearances for Service Access	10	3. Power Venting, Indoor Combustion Air in Confined or Unconfined Space	37
D. Residential Garage and Closet Installations	10	<b>Part 6 - Installing the Condensate Drain</b>	<b>38</b>
E. Exhaust Vent and Intake Pipe	11	<b>Part 7 - Connecting Electrical Service</b>	<b>39</b>
1. Direct Vent of Exhaust and Intake	11	A. Wiring	39
2. Power Venting, Indoor Combustion Air in Confined or Unconfined Space	11	B. Dip Switches	39
F. Carbon Monoxide Detectors	11	C. Wiring a Cascaded System	40
G. Prevent Combustion Air Contamination	12	<b>Part 8 - Gas Connections</b>	<b>45</b>
H. Removing a Heater from a Common Vent System	12	A. Gas Pipe Sizing Tables	45
I. Technical Specifications	13	1. Gas Pipe Sizing	45
J. Wall-Mounting	16	2. Natural Gas Pipe Sizing	45
<b>Part 4 - Water Piping</b>	<b>17</b>	3. LP (Liquid Propane) Gas Pipe Sizing	45
A. General Plumbing Guidelines	17	B. Gas Connection Requirements	45
B. Backflow Preventer	18	C. Additional Precaution for Excess Flow Valve (EFV)	46
C. Potable Expansion Tank	18	D. Checking Gas Pressure at the Water Heater for Proper Operation	46
D. Piping the Water Heater	18	E. Setting and Verifying the Combustion Setting	46
		<b>Part 9 - Controls</b>	<b>47</b>
		A. Control and Display Overviews	47
		B. Start-Up Sequence	47
		C. Changing the DHW Set-Point	48
		D. Changing the Time	48
		E. Lock Function	48
		F. Status Display	49
		G. Installer Mode	50
		H. Setting Up a Cascaded System	51
		I. Using Recirculation Modes - Step 1	52
		J. Recirculation Functions - Using Recirculation Modes - Step 2	53
		1. Smart Auto-Learn Recirculation Function	54
		2. Pro1, Pro2, Pro3, and PULS Recirculation Function	54
		<b>Part 10 - Troubleshooting</b>	<b>55</b>
		A. Error Code	55
		B. Error Tree Analysis	59
		1. Flame Detection	59
		2. Air Pressure Switch Detection	59
		3. Recirculation / Inlet / DHW / Operating Temperature / Exhaust Sensors	60
		C. Suggested Corrective Actions	60
		<b>Part 11 - Installation Checklist</b>	<b>62</b>
		<b>Part 12 - Maintenance</b>	<b>64</b>
		<b>Part 13 - Replacement Parts</b>	<b>67</b>
		Limited Warranty for RGH Water Heaters	72
		Notes	74
		Customer Installation Record Form	75





### Part 1 - General Safety Information

This water heater is approved for indoor installations only and is not intended for use as a pool heater. Clearance to combustible materials: 0" top, bottom, sides, and back. Heater must have room for service: 24" front, 3" left and right sides, 18" top, 12" bottom, and 0" back are minimum recommended service clearances. (A combustible door or removable panel is acceptable front clearance. A 3" minimum clearance must be provided from the appliance front cover to the removable panel or combustible door.) This water heater has been approved for closet installation and installation on combustible flooring. Do not install directly on carpeting. Install the water heater in a location where temperature and pressure relief valve discharge or a leak will not result in damage to the surrounding area. If such a location is not available, install an auxiliary catch pan. The appliance is rated Category IV (pressurized vent, likely to form condensate in the vent) and requires a special vent system designed for pressurized venting. Use only Category IV vent systems.

 <b>WARNING</b>
<b>Installer</b> - Read all instructions in this manual before installing. Perform steps in the given order.
<b>User</b> - This manual is for use only by a qualified heating installer / service technician. Have this water heater serviced / inspected annually by a qualified service technician.
<b>FAILURE TO ADHERE TO THE GUIDELINES ON THIS PAGE CAN RESULT IN SUBSTANTIAL PROPERTY DAMAGE, SEVERE PERSONAL INJURY, OR DEATH.</b>
<b>NOTE:</b> Obey all local codes. Obtain all applicable permits before installing the water heater.
<b>NOTE:</b> Install all system components and piping in such a manner that does not reduce the performance of any fire rated assembly.

#### A. Operation and Installation Warnings

To avoid serious injury or death, read, understand, and follow all of the precautions listed here.

 <b>DANGER</b>
Vapors from flammable liquids will explode and can cause a fire, resulting in personal injury or death. The water heater has a burner that can come on at any time and ignite vapors. DO NOT use or store flammable liquids around the water heater.
Improper venting can cause a build-up of carbon monoxide. Breathing carbon monoxide can result in brain damage or death. DO NOT operate the water heater unless it is properly vented to the outside and has an adequate fresh air supply for safe operation. Inspect the exterior exhaust gas outlet port and fresh air inlet port on a regular basis to ensure they are functioning properly.
A concentration of carbon monoxide as small as .04% (400 parts per million) in the air can be fatal. When making high fire or low fire adjustments, CO levels must be monitored using a flue gas analyzer such that a CO level of no more than 150 ppm is exceeded at any time during operation.
Adjusting the "low fire offset" or the "main flow restrictor" in small increments can result in a significant increase in CO concentration. To avoid serious injury or death, DO NOT make any adjustments to the gas valve without monitoring the exhaust gases with a fully functional and calibrated flue gas analyzer.
 <b>WARNING</b>
DO NOT allow children to operate this unit. DO NOT use this unit if it does not appear to be operating correctly. A qualified technician should service and inspect the water heater annually.

 <b>WARNING</b>
This water heater must be installed by a licensed plumber, licensed gas fitter, and/or professional service technician. Improper installation and/or operation can cause a potentially hazardous situation, which, if not avoided, could result in serious injury or death, and will void the warranty.
The manufacturer cannot anticipate every circumstance that might involve a potential hazard. Each installation has its own specialized characteristics, requirements, and possible hazards. Therefore, all possible incidents are not included in these warnings. Proper and safe installation, operation, and service are the responsibility of the professional service technician.
Proper care of the water heater is the user's responsibility. Ensure the user carefully reads and understands the User's Information Manual before operating and maintaining the water heater.
Make sure the user knows the location of the gas shut-off valve and how to operate it. Immediately close the gas shut-off valve if the water heater is subjected to fire, overheating, flood, physical damage, or any other damaging condition that might affect the operation of the unit. Have the water heater checked by a qualified technician before resuming operation.
Do not power up the unit unless the gas and water supply valves are fully opened. Make sure the fresh air intake port and exhaust gas port are open and functional.
No one but a professional service technician should attempt to install, service, or repair this water heater. There are no serviceable parts which can be changed by the user / owner. User / Owner: Contact the original professional service technician if the water heater needs repair or maintenance. If the original technician is unavailable, ask your gas supplier for a list of qualified service providers.
Keep the area around the water heater clean and free of all materials that can burn. DO NOT store or place gasoline, oils, spray paint, or other flammable products near the water heater.
DO NOT use spray paint, hair spray, or any other flammable spray near the water heater or near the exterior fresh air intake port. DO NOT place any items in or around the exterior exhaust gas outlet port and/or fresh air inlet port that could restrict or block the flow in or out of the vent system.
After installation, all water heater safety devices should be tested.
DO NOT store or place newspapers, laundry, or other combustible items near the water heater or the exterior exhaust gas outlet and/or fresh air inlet port.
The owner should inspect the system monthly for damage, water stains, signs of rust, corrosion, and exhaust vent and air intake blockage. If inspection of the unit shows signs of damage, the water heater should be shut off until the problem is repaired by a qualified technician.
This water heater is certified for indoor installations only. The water heater consists of gas ignition system components which must be protected from water (dripping, spraying, etc.) during operation and service. Carefully consider installation location and the placement of critical components (circulators, condensate neutralizers, etc.) before installing the water heater.
The water heater temperature is factory set to 125°F (51.7°C). To avoid scalding, always check the temperature of the hot water before bathing, showering, washing, etc. DO NOT adjust the water temperature while the water heater is being used by other persons.

## NOTICE

This water heater is equipped with a three prong plug. It should only be plugged directly into a properly grounded three prong receptacle. **DO NOT** remove the ground plug from the plug.

Any claims for damage or shortage in shipment must be filed immediately against the transportation company by the consignee.

This water heater provides a overheat shutdown limit. In the event the water heater water exceeds the set point of the control limit, the cutoff will trip and the water heater will shut down. Certain local codes require additional temperature limits. In addition, certain types of systems may operate at temperatures below the minimum set point of the limit provided with the water heater. Contact the manufacturer for additional overheat controls.

**NOTE:** When inquiring about service or troubleshooting, reference the model and serial numbers from the water heater rating label.

## WARNING

**DO NOT USE THIS WATER HEATER IF ANY PART HAS BEEN SUBMERGED IN WATER.** Immediately call a qualified service technician. The water heater **MUST BE** replaced if it has been submerged. Attempting to operate a water heater that has been submerged could create numerous harmful conditions, such as a potential gas leakage causing a fire and/or explosion, or the release of mold, bacteria, or other harmful particulates into the air. Operating a previously submerged water heater could result in property damage, severe personal injury, or death.

**NOTE:** Water heater damage due to flood or submersion is considered an Act of God, and **IS NOT** covered under product warranty.

**NOTE:** If the water heater is exposed to the following, do not operate. Immediately call a qualified service technician.

1. Fire
2. Damage
3. Water

Failure to follow this information could result in property damage, severe personal injury, or death.

**DO NOT** alter or modify the water heater or water heater controls. Altering any HTP water heater with parts not manufactured by HTP **WILL INSTANTLY VOID** the water heater warranty and could result in property damage, personal injury, or death.

This water heater has been designed to heat potable water **ONLY**. Using this water heater to heat non-potable fluid **WILL VOID** product warranty, and could result in property damage, personal injury, or death.

## CAUTION

Do not use this water heater for anything other than its intended purpose (as described in this manual). Doing so could result in property damage and **WILL VOID** product warranty.

### B. Improper Combustion

## WARNING

Do not obstruct the flow of combustion and ventilating air. Adequate air is necessary for safe operation. Failure to keep the exhaust vent and combustion air intake clear of ice, snow, or other debris could result in property damage, serious personal injury, or death.

### C. Gas

Should overheating or gas supply fail to shut off, turn off the manual gas control valve to the water heater.

### D. When Servicing the Water Heating System

## WARNING

Be sure to disconnect electrical power before opening water heater cabinet or performing service. Label all wires while performing service to ensure proper re-wiring of the water heater. Wiring errors can cause improper or dangerous operation. Failure to do so could result in an electrical shock, improper water heater operation, property damage, serious personal injury, or death.

- To avoid electric shock, disconnect electrical supply before performing maintenance.
- To avoid severe burns, allow water heater and associated equipment to cool before servicing.
- Do not use petroleum-based cleaning or sealing compounds in a water heating system. Gaskets and seals in the system may be damaged. This can result in substantial property damage.
- Do not use "homemade cures" or "patent medicines". Damage to the water heater, substantial property damage, and/or serious personal injury may result.
- Always verify proper operation after servicing the water heater.

**NOTE:** When inquiring about service or troubleshooting, reference the model and serial numbers from the water heater rating label.

### E. Water Chemistry Requirements

## CAUTION

Chemical imbalance of the water supply may affect efficiency and cause severe damage to the appliance and associated equipment. Water quality must be professionally analyzed to determine whether it is necessary to treat the water. Various solutions are available to adjust water quality. Adverse water quality will affect the reliability of the system. In addition, operating temperatures above 135°F will accelerate the build-up of lime scale and possibly shorten appliance service life. Failure of an appliance due to lime scale build-up, low pH, or other chemical imbalance **IS NOT** covered by the warranty.

The water must be potable, free of corrosive chemicals, sand, dirt, and other contaminants. It is up to the installer to ensure the water does not contain corrosive chemicals or elements that can damage the heat exchanger. Potable water is defined as drinkable water supplied from utility or well water in compliance with EPA secondary maximum contaminant levels (40 CFR Part 143.3). If the water contains contaminants higher than outlined by the EPA, water treatment is recommended and additional, more frequent maintenance may be required. See Table 1.

If you suspect that your water is contaminated in any way, discontinue use of the appliance and contact an authorized technician or licensed professional.

Contaminant	Maximum Allowable Level
Total Hardness (Commercial Use - Below 140°F water temperature)	200 mg/l (12 grains/gallon)
Total Hardness (Commercial Use - Above 140°F water temperature)	120 mg/l (7 grains/gallon)
Aluminum	0.05 to 0.2 mg/l or PPM
Chloride	100 mg/l or PPM
Copper	1 mg/l or PPM
Iron	0.3 mg/l or PPM
Manganese	0.05 mg/l or PPM
pH	6.5 - 8.5
Sulfate	205 mg/l or PPM
Total Dissolved Solids (TDS)	500 mg/l or PPM
Zinc	5 mg/l or PPM
Dissolved Carbon Dioxide (CO2)	15 mg/l or PPM

**Table 1 - Water Quality Specifications**

**F. Freeze Protection**

**CAUTION**

Consider piping and installation when determining heater location. Damages resulting from incorrect installation or from use of products not approved by HTP ARE NOT covered by warranty.

**WARNING**

NEVER use any toxic chemical, including automotive, standard glycol antifreeze, or ethylene glycol made for hydronic (non-potable) systems. These chemicals can attack gaskets and seals in water systems, are poisonous if consumed, and can cause personal injury or death.

The water heater control is equipped with freeze protection that activates based on internal water temperature. See the table below for details on freeze protection operation.

**NOTE:** Freeze protection will not be active if the water heater loses power.

	Freeze Protection Operation
System Freeze Protection (Activates Based on Internal Water Temperature)	<b>Stage 1</b> - If control detects water temperature of 46°F (8°C) and below, it turns the internal and external pumps On for 600 seconds and Off for 30 seconds. This cycle repeats until the control detects inlet water temperature of 50°F (10°C) and above.
	<b>Stage 2</b> - If control detects water temperature of 41°F (5°C) and below, it turns the burner on to meet a target temperature of 104°F (40°C). The burner and internal and external pumps will continuously during this stage until the control detects inlet water temperature of 104°F (40°C) and above.
	<b>Stage 3</b> - If control detects water temperature of 34°F (1°C) and below, Er: 85 will appear on the display.

**Table 2 - Freeze Protection Detail**

**G. Water Temperature Adjustment and Scalding**

This water heater can deliver scalding water. Be careful whenever using hot water to avoid scalding injury. Certain appliances such as dishwashers and automatic clothes washers may require increased water temperatures. By setting the thermostat on this heater to obtain the increased water temperature required by these appliances you may create the potential for scald injury.

To protect against injury, install a mixing valve in the water system. This valve will reduce point of use discharge temperatures by mixing cold and hot water in branch supply lines. Such valves are available

from your local plumbing supplier.

Table 3 details the relationship of water temperature and time with regard to scald injury and may be used as a guide in determining the safest water temperature for your applications.

Approximate Time / Temperature Relationships in Scalds	
120°F	More than 5 minutes
125°F	1 1/2 to 2 minutes
130°F	About 30 seconds
135°F	About 10 seconds
140°F	Less than 5 seconds
145°F	Less than 3 seconds
150°F	About 1 1/2 seconds
155°F	About 1 second

**Table 3 - Time and Temperature Relationship in Scalds**

**WARNING**

An ASSE 1017 or ASSE 1070 temperature limiting or mixing valve is recommended in installations servicing disabled or elderly persons, or children. Mixing valves do not eliminate the risk of scalding. To avoid scalding:

- Set the water heater set point temperature as low as possible.
- Feel water before bathing or showering.
- If thermostatic valves are required, use devices specifically designed for such purpose. Install these devices in accordance with instructions provided by the manufacturer.

Failure to install a temperature limiting or mixing valve and follow these instructions could result in property damage, severe personal injury, or death due to scalds.

Households with small children, disabled, or elderly persons may require a 120°F or lower temperature setting to prevent severe personal injury or death due to scalding.

**H. High Elevation Installations**

**WARNING**

Natural gas at high elevation might contain less heating value than typical 1,000 BTU/cu ft and therefore can cause improper air / gas mix leading to improper combustion. For natural gas installations above 3,000 ft, call your gas provider to determine the heating value of the supplied natural gas.

**! DANGER**

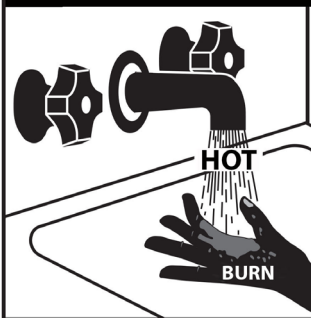

Water temperature over 125°F can cause severe burns instantly or death from scalds. Children, disabled and elderly are at highest risk of being scalded. See instruction manual before setting temperature at water heater. Feel water before bathing or showering. Temperature limiting valves are available, see manual.

## Part 2 - Before You Start







Open the shipping crate of the water heater.

### NOTICE

**UNCRATING THE WATER HEATER** - Any claims for damage or shortage in shipment must be filed immediately against the transportation company by the consignee.

#### A. What's in the Box







Components included with the water heater:

Item	Description	Quantity
Hybrid Water Heater		1
User and Installation Manuals		1 each
Condensate Hose (Part # - 7855P-089)		1
Anchors and Wall Mounting Bracket (7850P-084)		4
Spare Parts Kit (Gaskets, O-Rings, and Fuses) (7850P-280)		1
LP Conversion Kit - 150 Model (7855P-698) LP Conversion Kit - 199 Model (7855P-452)		1
Vent Screens (3") (7850P-085)		2 screens

**Table 4 - Included with the Water Heater**

#### B. Optional Equipment

Optional equipment available from HTP (and Part #):

Optional Parts		
Cascade Communication Cable (7850P-093)		One (1)
150 PSI Pressure Relief Valve (7850P-103)		1
3/4" Tankless DHW Isolation Valves (7850P-090)		2
Vent Screens (2") (7850P-088)		2 screens
On Demand / Title 24 Recirculation Kit (7855P-697)		1 Kit
Pipe Sensor (Surface Mount) (7250P-324)		1
Motion Sensor TACO 554-4		1

**Table 5 - Optional Equipment**



**Other Optional Equipment**

Below is a list of other optional equipment available from HTP. These additional options may be purchased through your HTP distributor:

- 2" PVC Concentric Vent Kit (Part # KGAVT0501CVT)
- 3" PVC Concentric Vent Kit (Part # KGAVT0601CVT)
- 2" Stainless Steel Outside Termination Vent Kit (Part # V500)
- 3" Stainless Steel Outside Termination Vent Kit (Part # V1000)
- 4" Stainless Steel Outside Termination Vent Kit (Part # V2000)
- 6" Stainless Steel Outside Termination Vent Kit (Part # V3000)
- 3" Polypro Vent Kit (Part # 8400P-001)
- 3" Polypro Pipe (33' length Part # 8400P-002, 49.5' length Part # 8400P-003)
- Condensate Neutralizer (Part # 7450P-212)
- Condensate Removal Pump (Part # 554200)

**Part 3 - Prepare the Water Heater Installation**

Remove all sides of the shipping crate to allow the heater to be moved into its installation location.

<b>CAUTION</b>
<p><b>COLD WEATHER HANDLING</b> - If the water heater has been stored in a very cold location (BELOW 0°F) before installation, handle with care until the components come to room temperature. Failure to do so could result in damage to the water heater.</p>
<p>Carefully consider installation when determining heater location. Please read the entire manual before attempting installation. Failure to properly take factors such as heater venting, piping, condensate removal, and wiring into account before installation could result in wasted time, money, and possible property damage and personal injury.</p>

**A. Locating the Water Heater**

<b>WARNING</b>
<p>This water heater is certified for indoor use only. DO NOT INSTALL OUTDOORS. Outdoor installations ARE NOT covered by warranty. Failure to install the water heater indoors could result in property damage, severe personal injury, or death.</p>
<p>Incorrect ambient conditions can lead to damage to the heating system and put safe operation at risk. Ensure that the installation location adheres to the information included in this manual. Failure to do so could result in property damage, serious personal injury, or death. Failure of heater or components due to incorrect operating conditions IS NOT covered by product warranty.</p>
<p>This water heater must be installed upright in the vertical position as described in this manual. DO NOT attempt to install this water heater in any other orientation. Doing so will result in improper water heater operation and property damage, and could result in serious personal injury or death.</p>

1. Installation Area (Mechanical Room) Operating Conditions

- Ensure ambient temperatures are higher than 32°F / 0°C and lower than 104°F / 40°C
- Prevent the air from becoming contaminated by the products, places, and conditions listed in this manual
- Avoid continuously high levels of humidity
- Never close existing ventilation openings
- Ensure a minimum 1" clearance around hot water and exhaust vent pipes
- **NOTE:** To prevent condensing in the fan, it is recommended to avoid prolonged exposure to temperatures below 45°F

<b>WARNING</b>
<p>This water heater has a condensate disposal system that may freeze if exposed to sustained temperatures below 32°F. Precautions should be taken to protect the condensate trap and drain lines from sustained freezing conditions. Failure to take precautions could result in property damage, severe personal injury, or death.</p>
<b>CAUTION</b>
<p>The service life of the water heater's exposed metallic surfaces, such as the casing, as well as internal surfaces, such as the heat exchanger, are directly influenced by proximity to damp and salty marine environments. In such areas higher concentration levels of chlorides from sea spray coupled with relative humidity can lead to degradation of water heater components. In these environments, heaters must not be installed using direct vent systems which draw outdoor air for combustion. Such heaters must be installed using room air for combustion. Indoor air will have a much lower relative humidity, and hence potential corrosion will be minimized.</p>

2. Check for nearby connections to:

- System water piping
- Venting connections
- Gas supply piping
- Electrical power
- Condensate drain

3. Check area around heater. Remove any combustible materials, gasoline, and other flammable liquids.

<b>WARNING</b>
<p>Failure to keep the water heater area clear and free of combustible materials, liquids, and vapors can result in substantial property damage, severe personal injury, or death.</p>

4. Gas control system components must be protected from dripping water during operation and service.

5. If the heater is to replace an existing heater, check for and correct any existing system problems, such as:

- System leaks
- Location that could cause the system and heater to freeze and leak
- Incorrectly sized expansion tank

6. Clean and flush system when reinstalling a heater.

<b>CAUTION</b>
<p>Do not connect the water heater to any heating systems or components that have been previously used for non-potable applications.</p>
<p>Do not introduce toxic chemicals, such as antifreeze or water heater treatments, into the water heater or any piping meant for potable water purposes.</p>
<p>Ensure that all piping and components connected to the water heater are suitable for potable water applications.</p>
<p>Do not use this water heater for space heating applications.</p>
<p>Circulators suitable for DHW applications must be used.</p>

**NOTE:** When installing in a zero clearance location, it may not be possible to read or view some product labeling. It is recommended to make note of the heater model and serial number.

## B. Leveling

### CAUTION

In order for the condensate to properly flow out of the collection system, the area where you locate the heater must be level. Location must also fully support the weight of the filled water heater.

## C. Clearances for Service Access

See Figure 1 and Table 6 for recommended service clearances. If these minimum clearances are not provided, it may not be possible to service the water heater without removing it from the space.

### WARNING

The space must be provided with combustion / ventilation air openings correctly sized for all other appliances located in the same space as the heater. The heater cover must be securely fastened to prevent the heater from drawing air from the heater room. This is particularly important if the heater is in a room with other appliances. Failure to comply with the above warnings could result in substantial property damage, severe personal injury, or death.

#### Minimum Clearances

Installation Clearances from Non-Combustibles / Combustibles	Recommended Service and Proper Operation Clearances
Top	18" (45.7 cm)
Back	0" (0 cm)
Bottom	12" (30.45 cm)
Front	24" (60.9 cm)
Right Side	3" (7.6 cm)
Left Side	

**Table 6 - Minimum Installation and Service Clearances**

**NOTE:** For closet installations, a combustible door or removable panel is acceptable front clearance. A 3" minimum clearance must be provided from the appliance front cover to the removable panel or combustible door.

**NOTE:** If you do not provide the minimum clearances shown in Figure 1 it might not be possible to service the heater without removing it from the space.

#### MINIMUM CLEARANCES FROM COMBUSTIBLE MATERIALS

- Hot water pipes - at least 1" from combustible materials
- Exhaust vent pipe - at least 1" from combustible materials

### CAUTION

Always take future maintenance into consideration when locating the water heater. If the water heater is located in an installation location with limited clearances, it may be necessary to remove the water heater from the space to perform maintenance. Failure to consider maintenance when determining installation location could result in property damage.

### CAUTION

All water heaters eventually leak. Locate the water heater where any leakage from the relief valve, related piping, tank, or connections will not result in damage to surrounding areas or lower floors of the building. Any water heater should be installed in such a manner that if it should leak the resulting flow of water will not cause damage to the area in which it is installed. National Plumbing codes require a drain pan for any water heater installation. Such a drain pan must have a clearance of at least 1.0" (2.5 cm) greater than any point on the water heater's outer jacket and must be piped to an adequate drain. Leakage damages ARE NOT covered by warranty. Failure to install a drain pan is the sole responsibility of the owner and/or installer. Reference UPC 2000 (Uniform Plumbing Code) Section 510 - Protection from Damage or IPC 200 (International Plumbing code) Section 504 - Safety Devices. Leakage damages ARE NOT covered by warranty. In addition, water leak detection devices and automatic water shutoff valves are readily available at plumbing supply houses. IT IS HIGHLY RECOMMENDED BY THE MANUFACTURER TO INSTALL WATER LEAK DETECTION DEVICES AND AUTOMATIC SHUTOFF VALVES IN ANY WATER HEATER INSTALLATION WHERE A LEAKAGE OF WATER COULD RESULT IN PROPERTY DAMAGES.

## D. Residential Garage and Closet Installations

### CAUTION

Check with your local Authority Having Jurisdiction for requirements when installing the water heater in a garage or closet. Please read the entire manual before attempting installation. Failure to properly take factors such as venting, piping, condensate removal, and wiring into account before installation could result in wasted time, money, and possible property damage and personal injury.

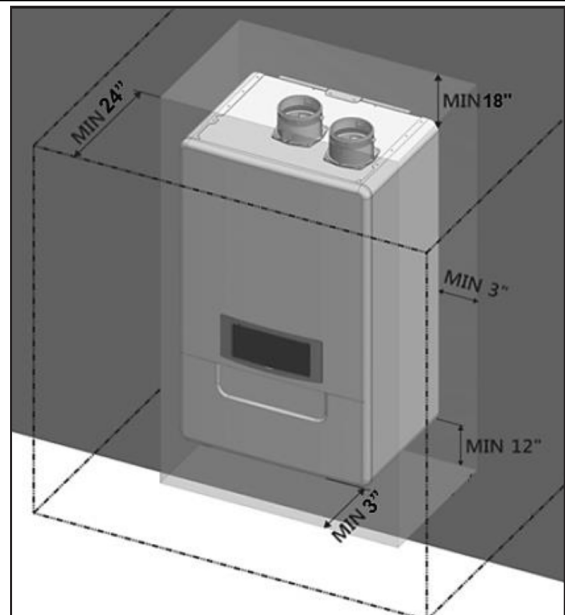

**Figure 1 - Minimum Service Clearances**

#### Precautions

If the heater is located in a residential garage, per ANSI Z223.1:

- Mount the bottom of the water heater a minimum of 18" above the floor of the garage to ensure the burner and ignition devices are well off the floor.
- Locate or protect the water heater so it cannot be damaged by a moving vehicle.

**WARNING**

The space must be provided with correctly sized combustion/ventilation air openings for all other appliances located in the space with the water heater. For power venting installations using room air for combustion, refer to the venting section, this manual, for descriptions of confined and unconfined spaces. Do not install the water heater in an attic. Failure to comply with these warnings could result in substantial property damage, severe personal injury, or death.

**E. Exhaust Vent and Intake Pipe**

The heater is rated Category IV (pressurized vent, likely to form condensate in the vent) and requires a special vent system designed for pressurized venting.

**NOTE: The venting options described here (and further detailed in the Venting section, this manual) are the lone venting options approved for this water heater. Failure to vent the water heater in accordance with the provided venting instructions will void the warranty.**

**DANGER**

Failure to vent the water heater properly will result in serious personal injury or death.

**WARNING**

Do not attempt to vent this water heater by any means other than those described in this manual. Doing so will void the warranty and may result in severe personal injury or death.

Vents must be properly supported. Heater exhaust and intake connections are not designed to carry heavy weight. Vent support brackets must be within 1' of the heater and the balance at 4' intervals. Heater must be readily accessible for visual inspection for first 3' from the water heater. Failure to properly support vents could result in property damage, severe personal injury, or death.

The exhaust discharged by this water heater may be very hot. Avoid touching or other direct contact with the exhaust gases of the vent termination assembly. Doing so could result in severe personal injury or death.

**1. Direct Vent of Exhaust and Intake**

If installing a direct vent option, combustion air must be drawn from the outdoors directly into the water heater intake and exhaust must terminate outdoors. There are three basic direct vent options detailed in this manual: 1. Side Wall Venting, 2. Roof Venting, and 3. Unbalanced Venting.

Be sure to locate the heater such that the exhaust vent and intake piping can be routed through the building and properly terminated. Different vent terminals can be used to simplify and eliminate multiple penetrations in the building structure (see Optional Equipment in Venting Section). The exhaust vent and intake piping lengths, routing, and termination methods must all comply with the methods and limits given in the Venting Section, this manual.

When installing a combustion air intake from outdoors, care must be taken to utilize uncontaminated combustion air. **To prevent combustion air contamination, see Table 7.**

**2. Power Venting, Indoor Combustion Air in Confined or Unconfined Space**

This heater requires fresh, uncontaminated air for safe operation and must be installed in a mechanical room where there is adequate combustion and ventilating air. **NOTE: To prevent combustion air contamination, see Table 7.**

Combustion air from the indoor space can be used if the space has adequate area or when air is provided through a duct or louver to supply sufficient combustion air based on the water heater input. Never obstruct the supply of combustion air to the water heater. If

the water heater is installed in areas where indoor air is contaminated (see Table 7) it is imperative that the water heater be installed as direct vent so that all combustion air is taken directly from the outdoors into the water heater intake connection.

**Unconfined space** is space with volume greater than 50 cubic feet per 1,000 BTU/hr (4.8 cubic meters per kW) of the total input rating of all fuel-burning appliances installed in that space. Rooms connected directly to this space through openings not furnished with doors are considered part of the space. See Venting Section for details.

**Confined space** is space with volume less than 50 cubic feet per 1,000 BTU/hr (4.8 cubic meters per kW) of the total input rating of all fuel-burning appliances installed in that space. Rooms connected directly to this space through openings not furnished with doors are considered part of the space.

When drawing combustion air from inside a conventionally constructed building to a confined space, such space should be provided with two permanent openings: one located 6" (15cm) below the space ceiling, the other 6" (15cm) above the space floor. Each opening should have a free area of one square inch per 1,000 BTU/hr (22cm<sup>2</sup>/kW) of the total input of all appliances in the space, but not less than 100 square inches (645cm<sup>2</sup>).

If the confined space is within a building of tight construction, air for combustion must be obtained from the outdoors as outlined in the Venting section of this manual.

**CAUTION**

When drawing combustion air from the outside into the mechanical room, care must be taken to provide adequate freeze protection.

**WARNING**

Failure to provide an adequate supply of fresh combustion air can cause poisonous flue gases to enter the living space, resulting in severe personal injury or death. To prevent combustion air contamination, see Table 7.

**F. Carbon Monoxide Detectors in the Commonwealth of Massachusetts and As Required by State and Local Codes:**

Installation of Carbon Monoxide Detectors: At the time of installation or replacement of the vented gas fueled appliance, the installing plumber or gas fitter shall observe that a hard wired carbon monoxide detector with an alarm and battery back-up is installed on the floor level where the gas appliance is installed, unless the appliance is located in a detached, uninhabitable structure separate from the dwelling, building, or structure used in whole or in part for residential purposes.

In addition, the installing plumber or gas fitter shall observe that a hard wired carbon monoxide detector with an alarm and battery back-up is installed on each additional level of the dwelling, building, or structure served by the vented gas appliance. It shall be the responsibility of the property owner to secure the service of qualified licensed professionals for the installation of hard wired carbon monoxide detectors.

a. In the event that the vented gas fueled appliance is installed in a crawl space or attic, the hard wired carbon monoxide detector with alarm and battery back-up shall be installed on the next adjacent floor level.

b. In the event that these requirements cannot be met at the time of completion of installation, the owner shall have a period of thirty (30) days to comply with the above requirements; provided, however, that during said thirty (30) day period, a battery operated carbon monoxide detector with an alarm shall be installed.

**WARNING**

Do not attempt to vent this water heater by any means other than those described in this manual. Doing so will void the warranty and may result in severe personal injury or death.

Approved Carbon Monoxide Detectors: Each carbon monoxide detector as required in accordance with the above provisions shall comply with NFPA 70 and be ANSI/UL 2034 listed and IAS certified.

**G. Prevent Combustion Air Contamination**

Install intake air piping for the heater as described in the Venting Section, this manual. Do not terminate exhaust in locations that can allow contamination of intake air.

<b>WARNING</b>	
Ensure that the intake air will not contain any of the contaminants in Table 7. Contaminated air will damage the heater, resulting in possible substantial property damage, severe personal injury, or death. For example, do not pipe intake air near a swimming pool or laundry facilities. These areas always contain contaminants.	
Products to Avoid	Areas Likely to Have Contaminants
Spray cans containing fluorocarbons	Dry cleaning / laundry areas and establishments
Permanent wave solutions	Swimming pools
Chlorinated waxes / cleaners	Metal fabrication plants
Chlorine-based swimming pool chemicals	Beauty shops
Calcium chloride used for thawing	Refrigeration repair shops
Sodium chloride used for water softening	Photo processing plants
Refrigerant leaks	Auto body shops
Paint or varnish removers	Plastic manufacturing plants
Hydrochloric or Muriatic acid	Furniture refinishing areas and establishments
Cements and glues	New building construction
Antistatic fabric softeners used in clothes dryers	Remodeling areas
Chlorine-type bleaches, laundry detergents, and cleaning solvents	Garages and workshops
Adhesives used to fasten building products	

**Table 7 - Products and Areas Likely to Have Contaminants**

**NOTE: DAMAGE TO THE HEATER CAUSED BY EXPOSURE TO CORROSIVE VAPORS IS NOT COVERED BY WARRANTY.** (Refer to the limited warranty for complete terms and conditions.)

**H. Removing a Heater from a Common Vent System**

**⚠ DANGER**

Do not install the heater into a common vent with any other appliance. This will cause flue gas spillage or appliance malfunction, resulting in possible substantial property damage, severe personal injury, or death.

**⚠ WARNING**

Failure to follow all instructions can result in flue gas spillage and carbon monoxide emissions, causing severe personal injury or death.

When removing an existing heater, follow the steps below.

1. Seal any unused openings in the common venting system.
2. Visually inspect the venting system for proper size and horizontal pitch to determine if there is blockage, leakage, corrosion, or other deficiencies that could cause an unsafe condition.

3. If practical, close all building doors, windows, and doors between the space in which the water heater remains connected to the common venting system and other spaces in the building. Turn on clothes dryers and any appliances not connected to the common venting system. Turn on any exhaust fans, such as range hoods and bathroom exhausts, at maximum speed. Do not operate a summer exhaust fan. Close all fireplace dampers.

4. Place in operation the appliance being inspected. Follow the lighting instructions. Adjust the thermostat so the appliance will operate continuously.

5. Test for spillage at the draft hood relief opening after 5 minutes of main burner operation. Use the flame of a match or candle or smoke from a cigarette.

6. After it has been determined that each appliance remaining connected to the common venting system properly vents when tested as outlined, return doors, windows, exhaust fans, fireplace dampers, and any other gas burning appliances to their previous condition of use.

7. Any improper operation of the common venting system should be corrected to conform to the National Fuel Gas Code, ANSI Z223.1. When resizing any portion of the common venting system, the system should approach the minimum size as determined using the appropriate tables in Appendix G of ANSI Z223.1.

**⚠ WARNING**

**Breathing Hazard - Carbon Monoxide Gas**

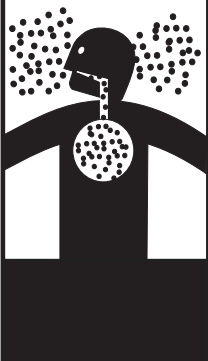

- Do not operate heater if flood damaged.
- Install vent system in accordance with local codes and manufacturers installation instructions.
- Do not obstruct heater air intake or exhaust. Support all vent piping per manufacturers installation instructions.
- Do not place chemical vapor emitting products near unit.
- According to NFPA 720, carbon monoxide detectors should be installed outside each sleeping area.
- Never operate the heater unless it is vented to the outdoors.
- Analyze the entire vent system to make sure that condensate will not become trapped in a section of vent pipe and therefore reduce the open cross sectional area of the vent.

Breathing carbon monoxide can cause brain damage or death. Always read and understand instruction manual.

LP-304

**Figure 2 - CO Warning Label**



## I. Technical Specifications

Model		150	199
Installation		Indoor, Wall Hung, Fully Condensing	
Minimum / Maximum Input (Btu/Hr)		15,000 / 150,000	19,900 / 199,000
Hot Water Capacity	35°F Rise	8.2 GPM	11 GPM
	45°F Rise	6.4 GPM	8.5 GPM
	77°F Rise	3.7 GPM	5 GPM
Flue System		Category IV, Sealed Combustion Direct Vent, Power Vent	
Vent Run		2" (50 feet), 3" (100 feet), Schedule 40 PVC, CPVC, PP	
Weight (lbs)		90	100
Orifice Size	NG	7.2 mm (0.284")	8.3 mm (0.327")
	LP	5.5 mm (0.217")	6.2 mm (0.240")
Gas Supply Pressure	NG	3.5" to 14" WC	
	LP		
Manifold Pressure	Min (3")	NG/LP: 0.006"	NG: 0.003" / LP: 0.004" WC
	Max (3")	NG/LP: -0.13"	NG: -0.19" / LP: -0.20" WC
Power Supply	Main Supply	120V 60 Hz, 10A	
	Maximum Power Consumption	72W (with Pump 100W)	
General Operating Conditions		Ambient Temperature Range: 33 – 104°F (0.6 – 40°C) Operating Relative Humidity: Up to 90% at 104°F (40°C) Shipping and Storage Temperature Range: -4 – 176°F (-20 – 80°C) Power Supply and Communication (CN4): 14V DC Product Approvals and Requirements EMC: 89/336/EEC LVD: 73/23/EEC	
Ignition System		Direct Electronic Ignition / Automatic Flame Sensing	
Burner System		Single Orifice Premixed Fuel Modulation / Ceramic Fiber Burner	
Gas Valve System		Air Ratio Valve	
Minimum Flow Rate		0.5 GPM (zero activation with internal recirculation mode active)	
Internal Pipe Material		Copper	
Dimensions		W 17.5" - H 30" - D 15.5"	W 19.7" - H 32" - D 16.3"
Heat Exchanger Water Capacity (DHW)		2.3 Gallons	3.5 Gallons
Control Panel / Main Controller		P-950CH / NGTH-10CH	
Water Pressure		Min 12 - Max 150 PSI	
DHW Setpoint Temperature Range		100 – 140°F (35 – 60°C)	
Connection Sizes	Cold Water Inlet / Hot Water Outlet / Recirculation Return	3/4" NPT	
	Gas Inlet	3/4" NPT	
Materials	Cabinet	Cold Rolled Carbon Steel	
	Heat Exchanger	316L Stainless Steel	
Safety Devices		Optical Flame Sensor, Burner Plate High Limit (392°F), Water Temperature High Limit Sensor (203°F), Water Leak Detection, Freeze Protection (Three Stage Operation - Activates at 46°F – See Freeze Protection in Installer Menu for Details), Exhaust Temperature High Limit Sensor (190°F), Blocked Flue and Intake Sensor, Condensate Switch, Built-In Low Water Cut-Off Probe	

Table 8 - Technical Specifications

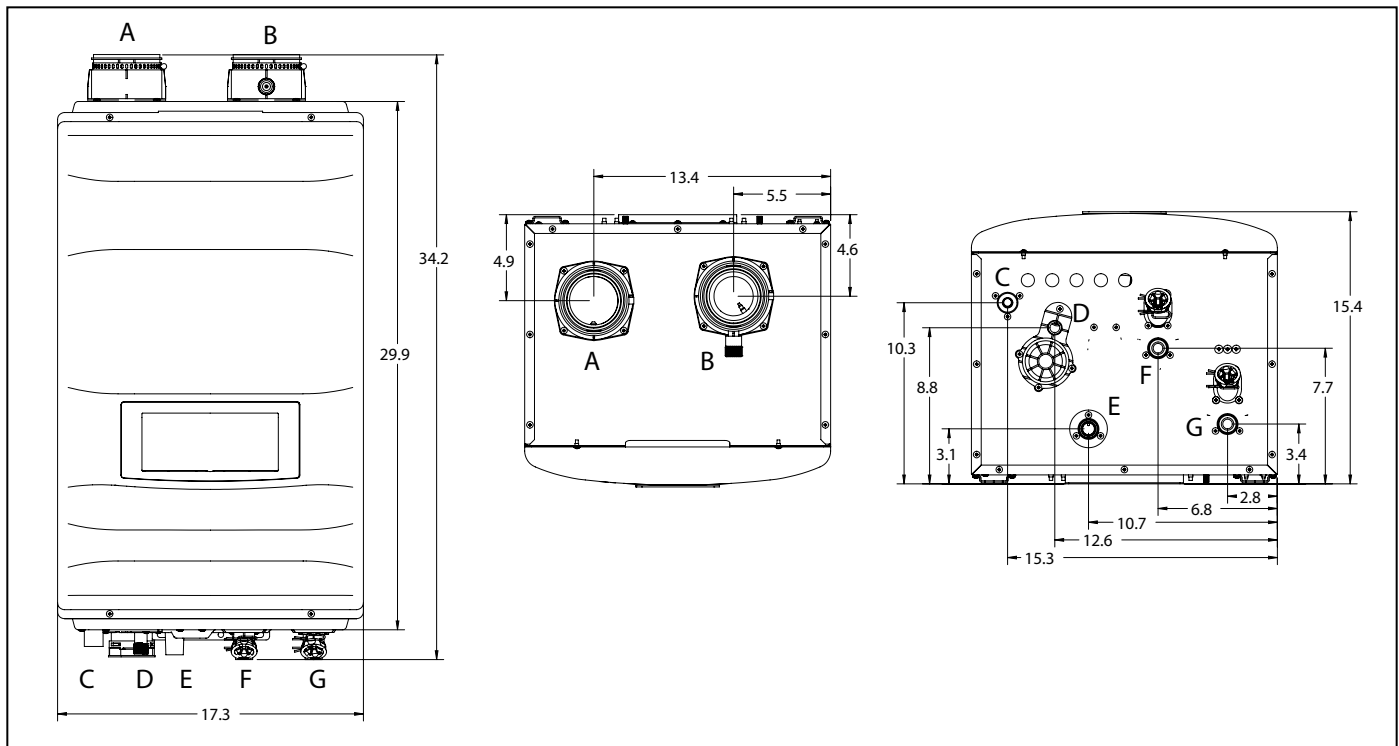

Figure 3 - 150 Model Dimensions

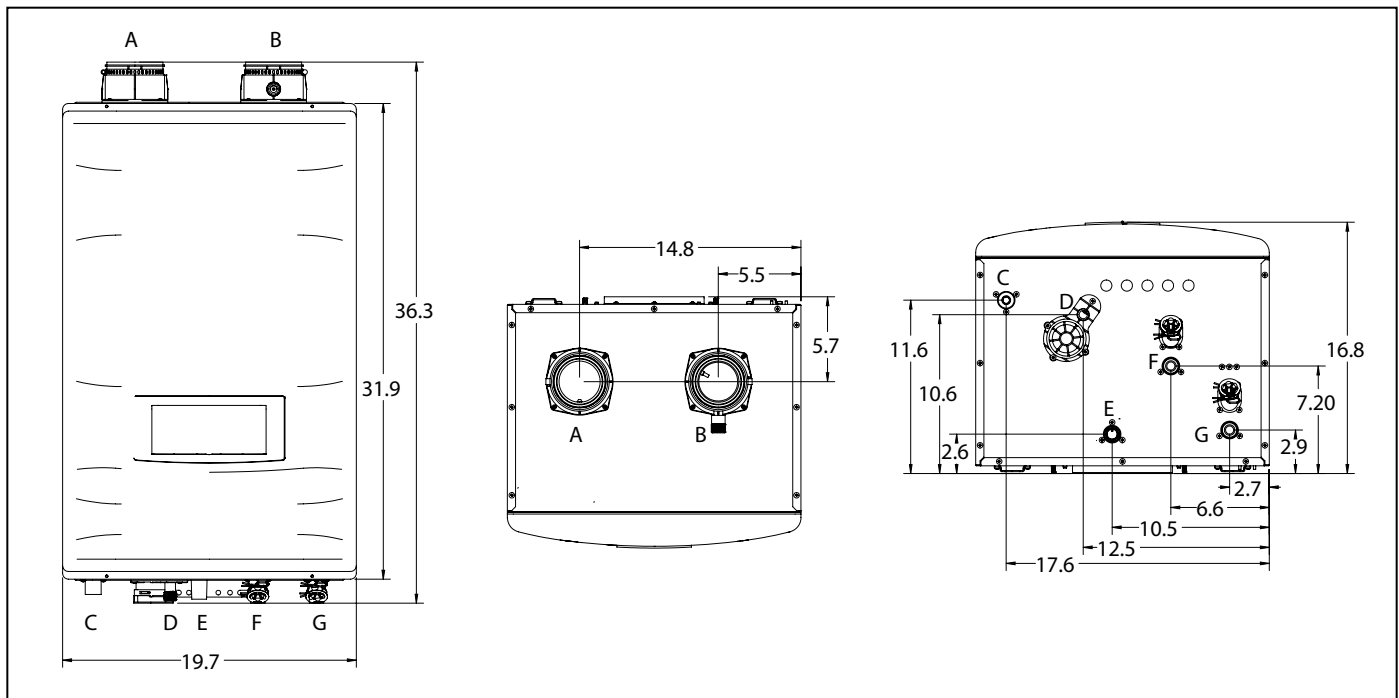

Figure 4 - 199 Model Dimensions

	Description	Diameter
A	Air Intake Adapter	3"
B	Exhaust Outlet Adapter	3"
C	Gas Inlet Adapter	3/4" NPT
D	Condensate Adapter	1/2" NPT
E	DHW Outlet Adapter	3/4" NPT
F	DHW Inlet Adapter	3/4" NPT
G	Recirculation Return Adapter	3/4" NPT

Table 9 - Adapter Specifications

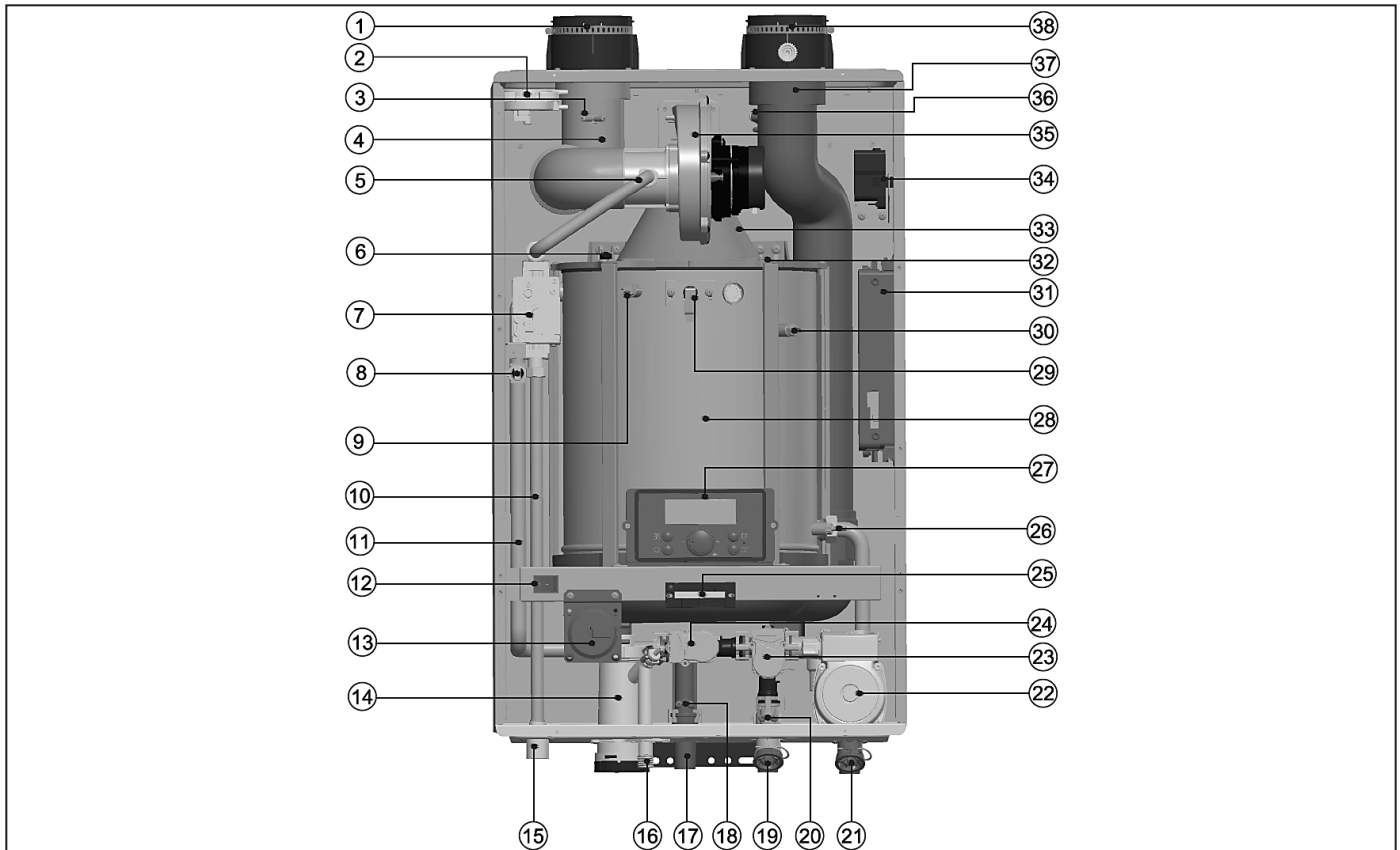

Figure 5 - Components

Number	Component Description	Number	Component Description	Number	Component Description
1	Air Intake Pipe Adapter	14	Condensate Trap	27	Control Panel
2	Flue Air Pressure Sensor	15	Gas Pipe Adapter	28	Heat Exchanger
3	Air Inlet Orifice	16	Condensate Adapter	29	Flame Detection Sensor
4	Air Inlet Pipe	17	Hot Water Adapter	30	Water Level Detection Sensor
5	Gas Outlet Pipe	18	Hot Water Thermistor	31	Main Control Board
6	Burner High Limit Switch	19	Cold Water Inlet Adapter	32	Igniter Rod
7	Gas Valve	20	Cold Water Thermistor	33	Burner Case
8	Hot Water High Limit Switch	21	Recirculation Return Adapter	34	Igniter Transformer
9	Heat Exchanger Water Thermistor	22	Recirculation Pump	35	BLDC Fan
10	Gas Inlet Pipe	23	Flow Control Valve	36	Exhaust Thermistor
11	Hot Water Outlet Pipe	24	Water Mixing Valve	37	Exhaust Duct
12	Manual ON/OFF Power Switch	25	Terminal Strip	38	Exhaust Vent Adapter
13	Condensate Air Pressure Switch	26	Recirculation Return Water Sensor		

Table 10 - Component List

**How the Water Heater Operates**

Condensing technology intelligently delivers water heating while maximizing efficiency. Outlined below are the features of the system and how they operate:

**Stainless Steel Heat Exchanger** - The highly efficient 316L stainless steel fire tube heat exchanger with internal aluminum is designed to extract all available heat from the combustion process and pass it into heat transfer fluid. The stainless steel construction provides protection for longer service life. The heat exchanger offers greater water content, providing lower system pressure and greater overall system efficiency.

**10 to 1 Modulating Combustion System** - The combustion system is specially designed to provide very high turn down. This combustion system will modulate the burner output to very low levels to match the system demand and achieve better overall control of the heating system for maximum efficiency and reliability.

**Control** - The integrated control system monitors the system and

responds to internal and external signals to regulate fan speed and control output. This allows the water heater to deliver only the amount of hot water required and nothing more.

The control can regulate the output of multiple water heaters through its cascade system function by establishing one water heater as the master and the other connected water heaters as followers. The master water heater requires a sensor to provide feedback on set point temperature in order to adjust heating output from the connected water heaters. Multiple water heater cascaded systems offer greater system turndown and redundancy.

**Electronic LCD Display** - The high resolution display allows the user to monitor water heater functions. The display also provides the means to program the system parameters to maximize the efficiency of the system design.

**Combustion System (Blower - Gas Valve - Mixer - Burner - Spark Ignition)** - The highly efficient spark ignition combustion system uses a variable speed blower to adjust combustion as the system requires

more or less energy. The negative regulated gas valve provides only the amount of fuel required to ensure clean combustion. The mixer accurately regulates the combination of gas and air throughout the modulating range to ensure high reliability. The burner is constructed of durable ceramic metal fiber for long service life.

**Water Heater Sensors (Inlet – Outlet – Flue)** - Sensors provide highly accurate temperature monitoring to assure accurate system control. These sensor inputs can be monitored through the water heater control system and display.

**Pressure Gauge** – Allows the user to monitor system pressure.

**System Safeties** – The water heater is provided with many safety features to ensure reliable and safe operation. Each safety is connected to the water heater control. The water heater will alert the user if an unsafe condition occurs and needs to be addressed. The following are provided safeties: Flue Pressure Switch (monitors flue pressure), Burner High Limit (monitors burner plate temperature), High Limit Water Switch (monitors water heater water temperature), Low Water Sensor (monitors water level in the heat exchanger), optic flame sensor (monitors flame quality), Flue Sensor (monitors flue temperature), Condensate Pressure Switch (monitors pressure to ensure condensation does not back up into water heater).

**Manual Air Vent** – Each water heater is equipped with an air vent to discharge air from the system during start-up.

**Intake and Exhaust Adapters** – The water heater is equipped with adapters to ease connection to the vent system. The adapters are provided with clamps and seals to secure field supplied piping, and test ports to ease monitoring of the combustion system.

**3/4" Inlet and Outlet Connections** – Water heaters are equipped with bottom piping connections for greater installation flexibility.

**Gas Connection** – The water heater is equipped with a 3/4" gas connection to connect the incoming gas supply.

**Field Wiring and Power Switch** – Each water heater is supplied with a power switch to cut off power. The water heater is also equipped with two front mounted terminal strips. These terminal strips are separated into low and line voltage to ease system wiring.

**Condensate Trap and Hose Assembly** – Each water heater has a built-in condensate trap to control the discharge of condensate produced by the water heater during normal operation. A corrugated condensate hose is also provided to ensure proper drainage of condensate into the pump or drain.

**Low Water Cut Off Probe** – LWCO is provided with each water heater to assure the water heater has adequate water level to eliminate overheating and even damaging the water heater heat exchanger.

**Pump Service Mode** – Allows manual operation of pumps to commission system and check pump operation.

**Cascade Operation** - This water heater can be configured to run with multiple units in a Cascade System. In a Cascade System, multiple water heaters are installed, piped, and wired to cooperate in a single system. This provides many advantages over a single large capacity water heater, including increased turndown, system redundancy, and increased efficiency. A maximum of sixteen (16) water heaters can be controlled by a single water heater designated as the "Master". Other connected water heaters are designated as "Followers".

The Master controls the operational run time of the connected Followers and modulates the connected units up or down to ensure

the units are putting only the needed energy into the connected storage tank, and also to ensure all connected units get even run time to balance out service requirements.

When the Master water heater receives a DHW demand, the Master will energize the lead water heater in the cascade system. In a new system start-up this will be the Master. The water heater will fire at its ignition speed and then modulate its firing rate to maintain the set point. If the first water heater reaches 80% of its firing rate, the Master will modulate down and split the load in half with the next unit in the system service rotation. At this point, the Master will fire the second water heater in the system. If there are more than two water heaters in the system, the same principle will be applied. Once the lead water heater reaches 80% of its firing rate, it will modulate down and split the total amount of load by the total number of units in the cascaded system.

If the set point still cannot be met, the Master will continue firing more Followers until either the DHW demand is met or all water heaters in the cascade system are firing at the maximum rate. As the heat demand decreases, all operating water heaters will modulate down according to the heating load. The first water heater to modulate down to 30% will shut off. The same principle will be applied to the remaining water heaters in operation until the DHW demand is satisfied. When the demand is satisfied, the water heaters will turn off.

## J. Wall-Mounting

### WARNING

The water heater must be installed on a wall that can bear its weight (more than 100 lbs. when fully plumbed and full of water). Installing the water heater on a wall which cannot support its weight could result in property damage, personal injury, or death.

The water heater may be installed on any suitable internal wall (suitable sound-proofing may be required when installing onto a stud partition wall).

### WARNING

This water heater is too heavy for one person to lift. It is highly recommended to install the water heater with two people. Use caution as to not drop the water heater, which could damage the water heater and cause property damage and/or severe personal injury. Verify that the water heater is properly and securely mounted before leaving unsupervised. Failure to comply with the above and properly mount the water heater could result in substantial property damage, severe personal injury, or death.

This wall mounting system is not seismic rated and should not be applied as such. Failure to comply with the above and properly mount the water heater could result in substantial property damage, severe personal injury, or death.

### Positioning the Water Heater on the Wall

1. Attach the wall bracket on the location where you want to install the water heater. Ensure it is level and on stud (16" centers) before proceeding.
2. Mark the four drill holes with a pencil or marker. Remove the wall bracket.
3. Drill four (4) holes using a 5/32 drill bit at the marked hole locations.
4. Mount the wall bracket to the wall with the four (4) included anchor bolts. Ensure the mounted bracket is level. See Figure 6A.
5. Align the heater bracket grooves on the back of the water heater with the tongues on the wall bracket and hang the water heater on the bracket. See Figure 6B.

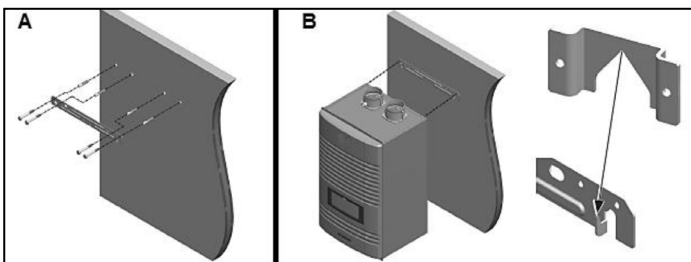

Figure 6 - Wall-Mounting the Water Heater



**Part 4 - Water Piping**

<b>WARNING</b>
Failure to follow the instructions in this section WILL VOID the warranty and may result in property damage, severe personal injury, or death.
<b>CAUTION</b>
DO NOT pipe this water heater with black iron, galvanized steel, steel, or lead pipe. Doing so will result in premature product failure and property damage, and WILL VOID the warranty.
Do not apply a torch within 12" of the water heater. If sweat connections are used, sweat tubing to the adapter before fitting adapter to the water connections on the heater. Damages due to improper installation practices ARE NOT covered by warranty.
Dielectric unions or galvanized steel fittings must not be used in a system with this water heater. Doing so WILL VOID the warranty. Use only copper, brass, or stainless steel fittings. Teflon thread sealant must be used on all connections.

**A. General Plumbing Guidelines**

<b>CAUTION</b>
Use two wrenches when tightening water piping at heater. Use one wrench to prevent the heater inlet or outlet line from turning. Failure to prevent piping connections from turning could cause damage to heater components.
The heater control module uses temperature sensors to provide both high limit protection and modulating temperature control. The control module also provides low water protection by sensing the water level in the tank. Some codes / jurisdictions may require additional external controls.

The domestic water connections must be installed in accordance with all local and national plumbing codes, or any applicable standard which prevails. The inlet (cold), outlet (hot), and recirculation inlet ports are 3/4" on all models.

- Pipe material must be suitable to meet local codes and industry standards.
- The pipe must be cleaned and without blemish before any connections are made.
- Isolation (shutoff valves) should be used to ease future servicing. HTP offers isolation valves (Part #7850P-090). These optional parts may be purchased separately.
- All water piping should be insulated.

It is recommended to install a sweat shut-off valve and a union in the cold inlet piping and hot outlet to ease future servicing. If there is a backflow preventer or any type of a no return valve in the system, install an additional tee here, suitable for a potable hot water expansion tank.

In the hot outlet, install a suitable adapter to match the tubing of the plumbing system. A thermal trap or heat trap loop may be installed here to provide additional energy savings and prevent the thermal siphoning of domestic hot water.

**Operating Modes**

**Standard (DHW) Mode** – This is the operating mode when there is a call for hot water.

**Preheat or Internal Recirculation Modes** – When calls for hot water are satisfied, the water heater is factory programmed to Preheat and automatically maintain the temperature set point of the water heater – 24 hours a day, 7 days a week. The differential setting can be adjusted to control the temperature set point.

Internal Recirculation Mode allows the installer to program specific recirculation functions by day and time to circulate and heat water more efficiently - when the user most needs hot water. See Recirculation Functions, this manual, for details.

**External Recirculation Mode** – This mode keeps an external recirculation loop warm to make hot water production more efficient and also aid in freeze protection. An external recirculation line must be installed in order to recirculate water externally. The installer may program specific recirculation functions by day and time to circulate and heat water when the user most needs hot water. See Recirculation Functions, this manual, for details.

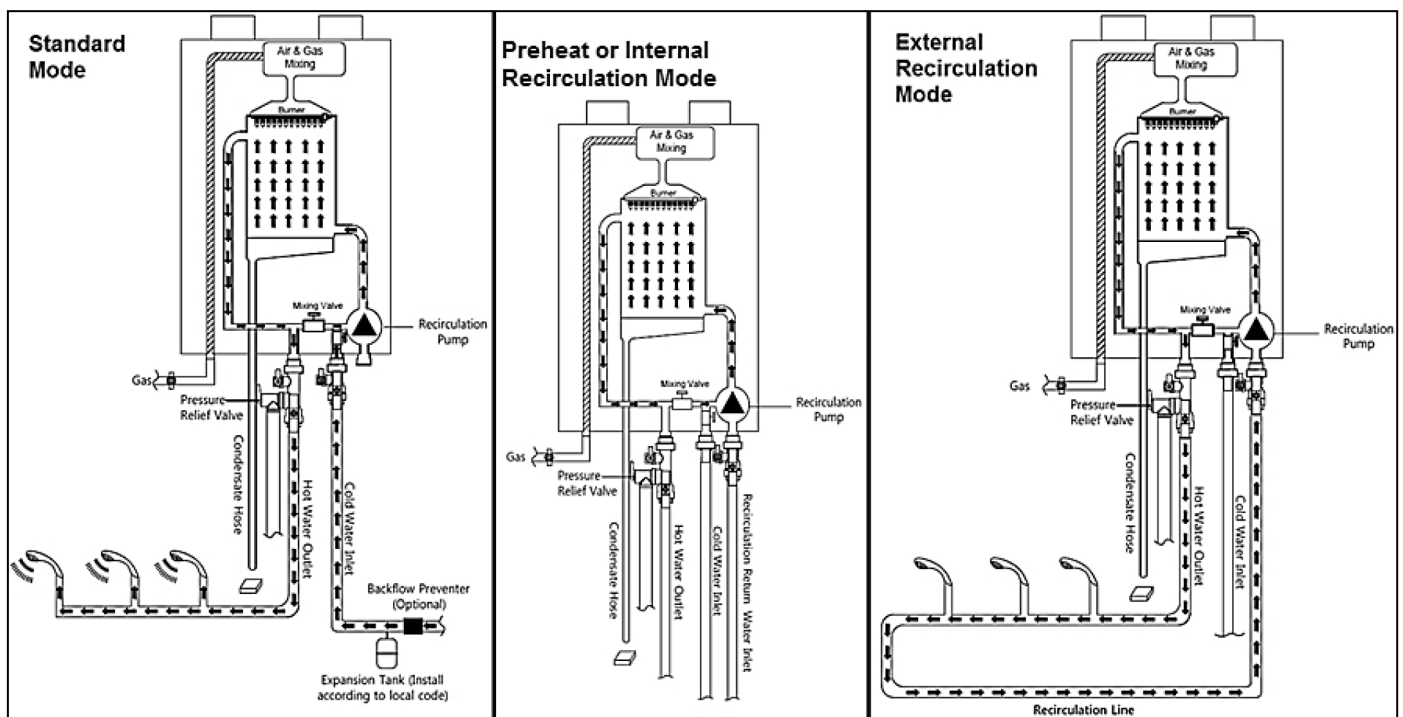

**Figure 7 - Operating Modes**

**B. Backflow Preventer**

Use a backflow preventer specifically designed for water heater installations. This valve should be installed on the cold water fill supply line per local codes.

**C. Potable Expansion Tank**

A potable hot water expansion tank is required to offset heated water expansion. In most city plumbing systems, the water meter has a no return or back flow device built into the system to prevent back flowing of water into city mains. Some local codes require back flow preventers on all incoming water supplies. The hot water expansion tank must be listed for potable water use. The expansion tank should be located on the cold inlet piping close to the water heater.

**Expansion Tank**

1. Ensure that the potable expansion tank is sized to correctly handle water heater (3.5 gallon capacity), related piping, and connected storage volume and system temperature.

<b>CAUTION</b>
Undersized expansion tanks cause system water to be lost from the relief valve, causing make-up water to be added. Eventual heater failure can result due to excessive make-up water addition. <b>SUCH FAILURE IS NOT COVERED BY WARRANTY.</b>
The expansion tank must be suitable for hot potable water systems.

2. The expansion tank must be located as shown in Applications, this manual, or following recognized design methods. See expansion tank manufacturer's instructions for details.

**D. Piping the Water Heater**

<b>CAUTION</b>
Use at least the MINIMUM pipe size for all water heater loop piping This is to avoid the possibility of inadequate flow through the water heater. Using less than the required minimum pipe size and piping could result in system problems, property damage, and premature water heater failure. Such problems ARE NOT covered by product warranty.

Use both thread tape and pipe dope to connect to the 3/4" domestic water inlet and outlet, and recirculation inlet (if applicable). Tankless isolation valves between the city water supply and tank inlet are recommended for ease of service.

**E. Applications**

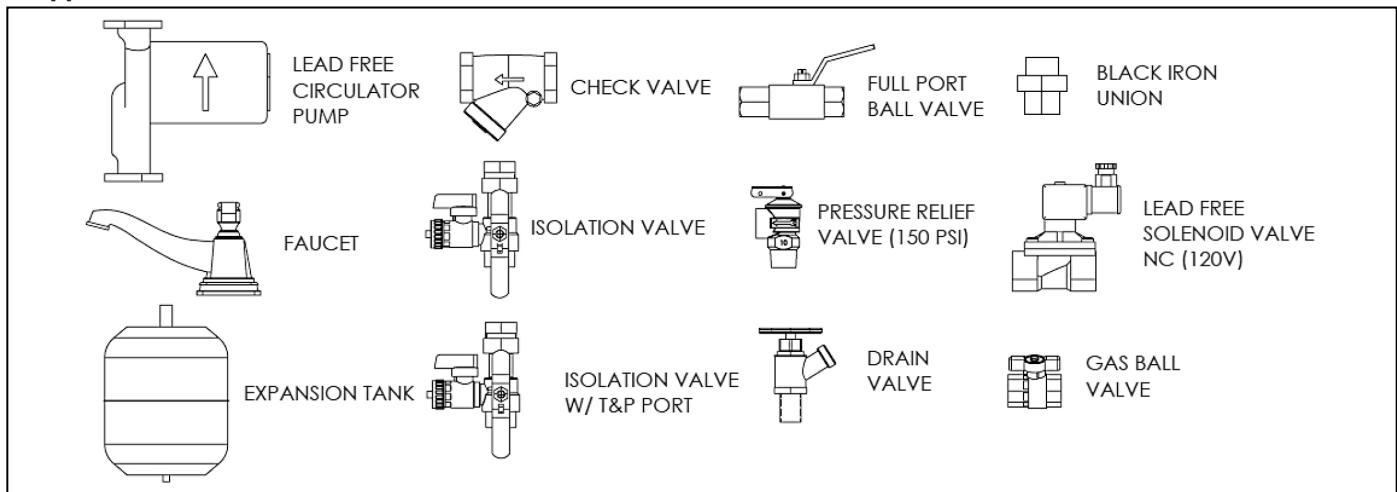

**Figure 8 - Piping Symbol Legend**

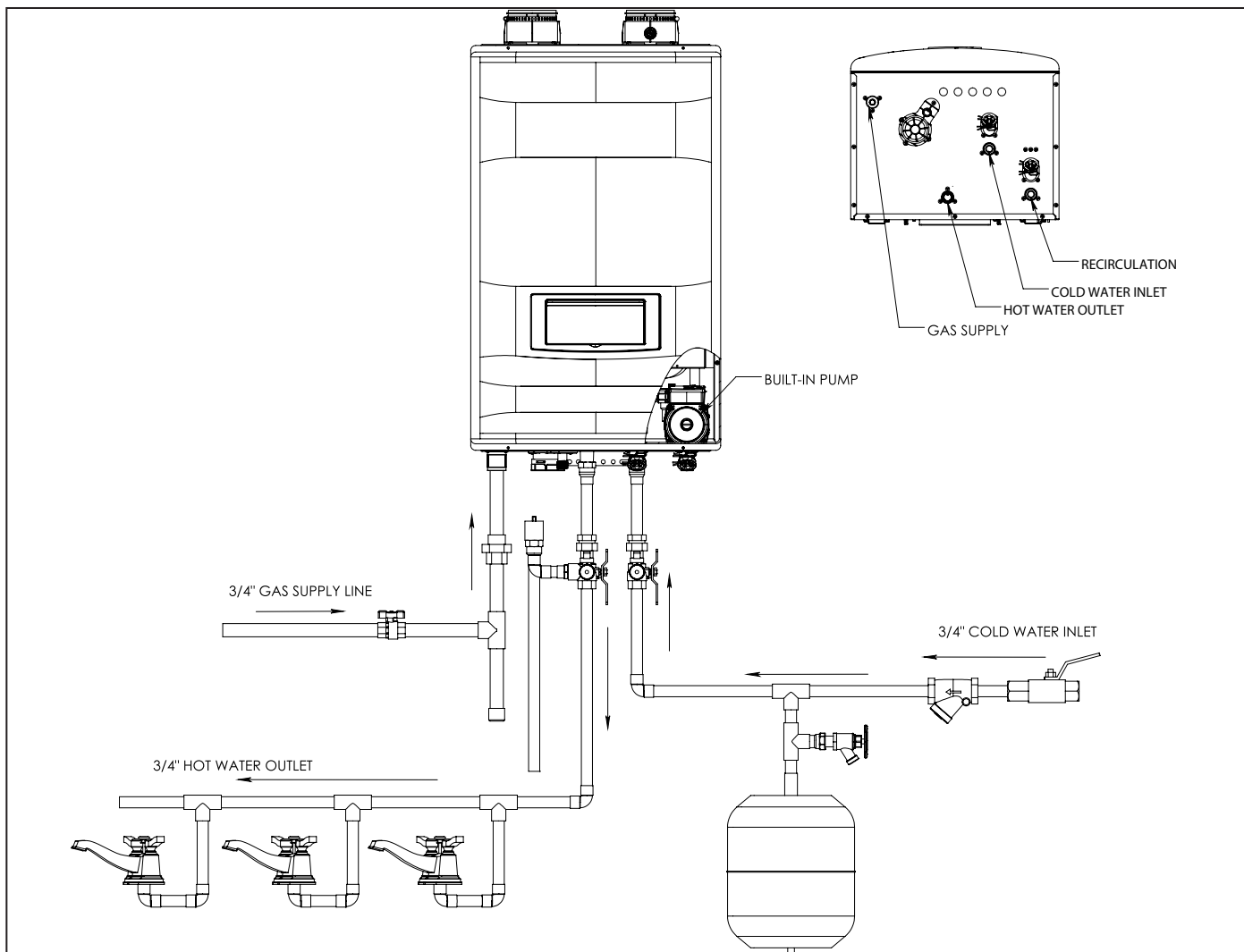
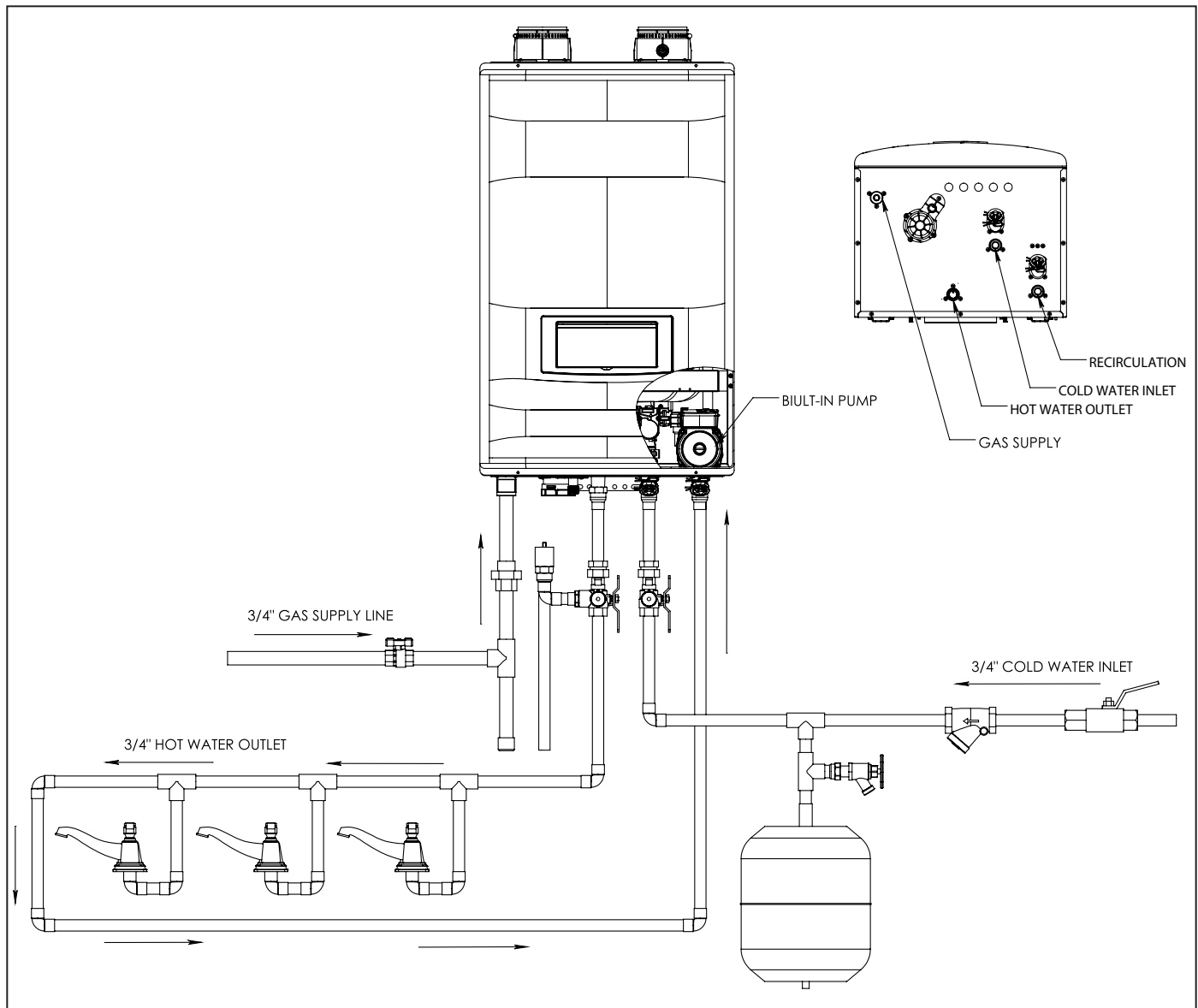

**Figure 9 - DHW Piping, Single Water Heater - NOTE: There is a Built-In Flow Check in the Internal Pump Loop**

**NOTES:**

1. Minimum pipe size should match connection size. Upsize pipe accordingly if greater flow is required.
2. A thermal expansion tank suitable for potable water must be sized and installed within this piping system between the backflow preventer and the cold water inlet.
3. All circulators should have an integral flow check.
4. Drains and check valve between water heater and piping will assist in purging air from system.
5. These drawings are meant to demonstrate system piping only. The installer is responsible for all equipment and detailing required by local codes. In Massachusetts, you must install a vacuum relief valve per 248 CMR.
6. Mixing valve application is optional, but recommended to help prevent scalding.
7. Always shut off power to the water heater or isolate the heater from the system if ANY plumbing work is to be done. Running the water heater without water will result in dry-firing.

**NOTE:** These drawings are meant to show system piping concept only. Installer is responsible for all equipment and detailing required by local codes.



**Figure 10 - Piping with Recirculation - NOTE: There is a Built-In Flow Check in the Internal Recirculation Pump Loop**

**NOTE:** For installations where internal pump is not adequate for the recirculation loop, an additional pump can be installed and powered by the appliance (2A Max). See Pressure Drop and Pump Curves, this manual.

**NOTES:**

1. Minimum pipe size should match connection size. Upsize pipe accordingly if greater flow is required.
2. A thermal expansion tank suitable for potable water must be sized and installed within this piping system between the backflow preventer and the cold water inlet.
3. All circulators should have an integral flow check.
4. Drains and check valve between water heater and piping will assist in purging air from system.
5. These drawings are meant to demonstrate system piping only. The installer is responsible for all equipment and detailing required by local codes. In Massachusetts, you must install a vacuum relief valve per 248 CMR.
6. Mixing valve application is optional, but recommended to help prevent scalding.
7. Always shut off power to the water heater or isolate the heater from the system if ANY plumbing work is to be done. Running the water heater without water will result in dry-firing.

**NOTE:** These drawings are meant to show system piping concept only. Installer is responsible for all equipment and detailing required by local codes.



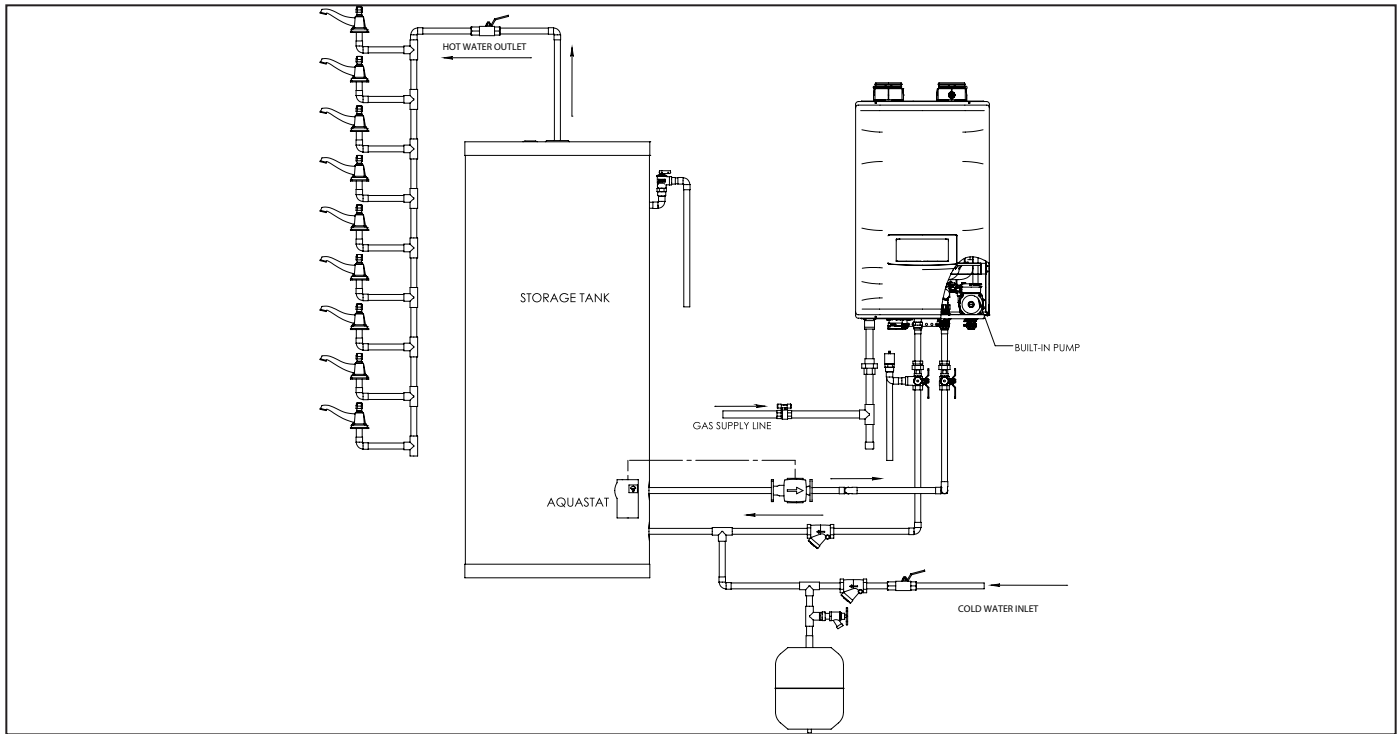

**Figure 11 - Water Heater with Storage Tank - NOTE: There is a Built-In Flow Check in the Internal Pump Loop**

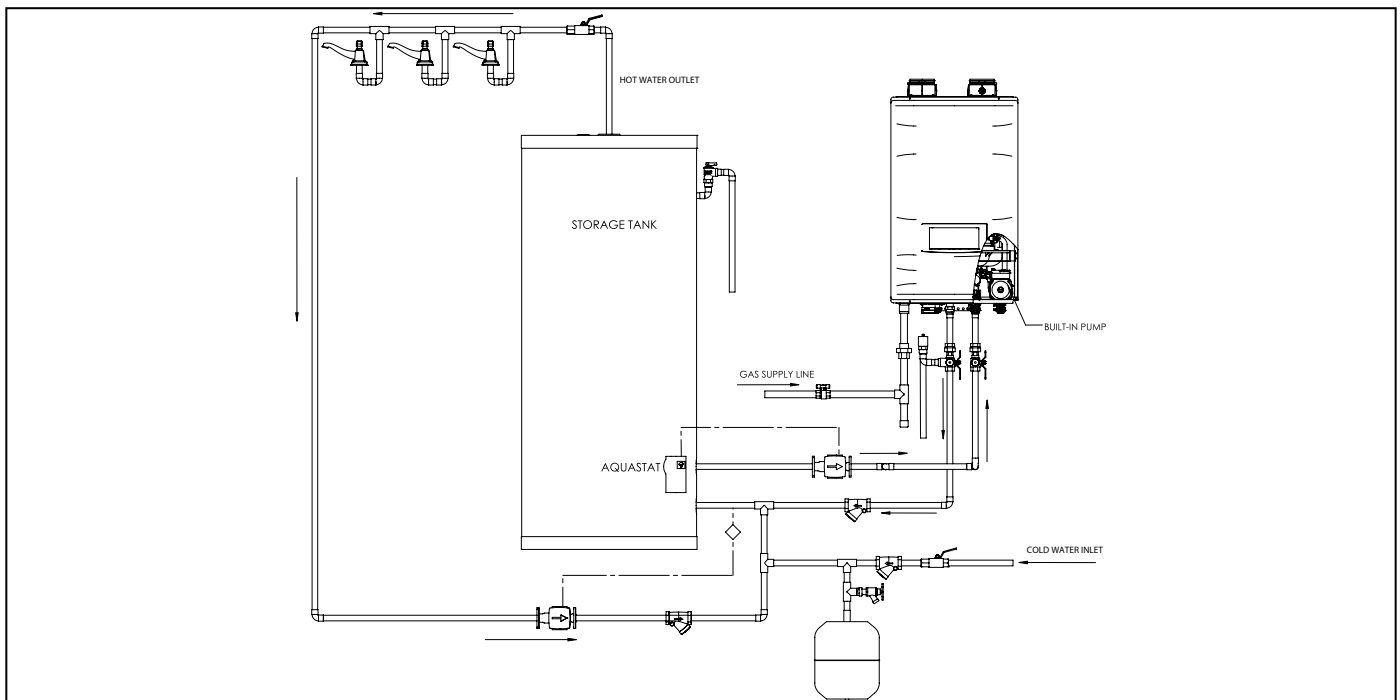
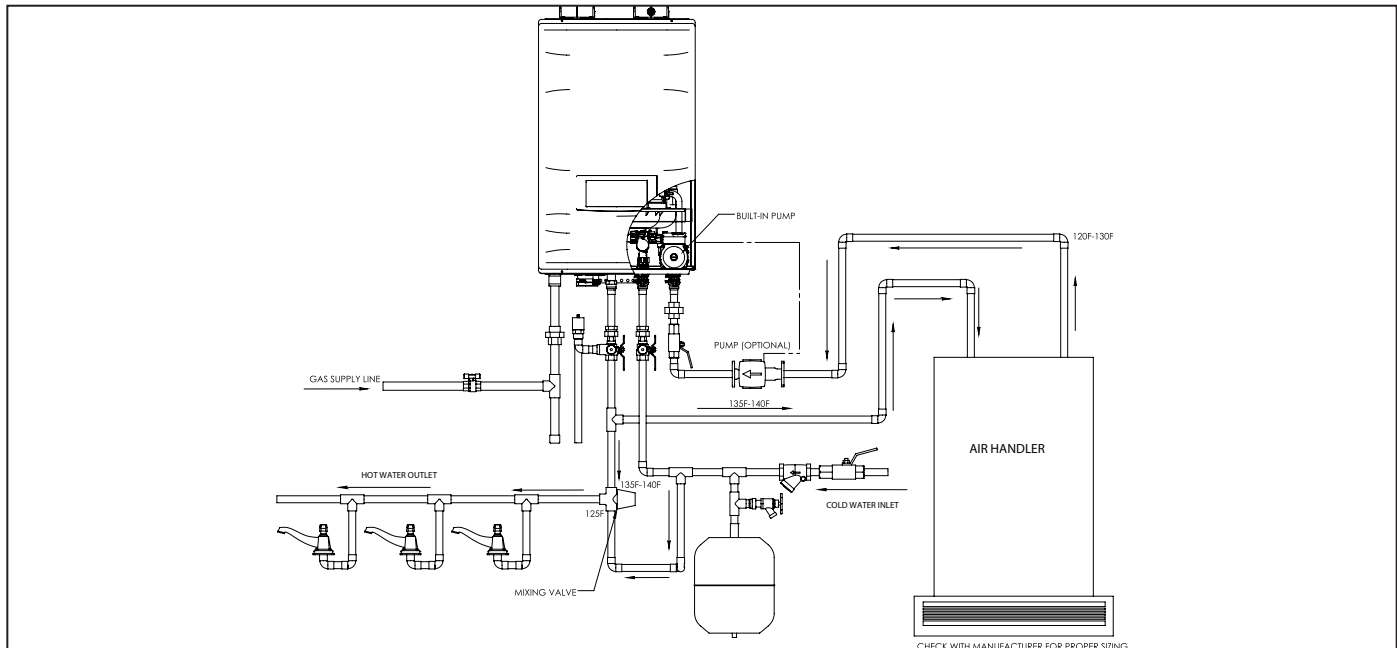

**Figure 12 - Water Heater with Storage Tank and Recirculation - NOTE: There is a Built-In Flow Check in the Internal Recirculation Pump Loop**

**NOTES:**

1. Minimum pipe size should match connection size. Upsize pipe accordingly if greater flow is required.
2. A thermal expansion tank suitable for potable water must be sized and installed within this piping system between the backflow preventer and the cold water inlet.
3. All circulators should have an integral flow check.
4. Drains and check valve between water heater and piping will assist in purging air from system.
5. These drawings are meant to demonstrate system piping only. The installer is responsible for all equipment and detailing required by local codes. In Massachusetts, you must install a vacuum relief valve per 248 CMR.
6. Mixing valve application is optional, but recommended to help prevent scalding.
7. Always shut off power to the water heater or isolate the heater from the system if ANY plumbing work is to be done. Running the water heater without water will result in dry-firing.
8. When using unit with storage tank, the setpoint of the water heater needs to be at least 20°F higher than the setpoint of the Aquastat on the tank. Pump selection must meet a minimum flow rate requirement of 2 GPM.

**NOTE:** These drawings are meant to show system piping concept only. Installer is responsible for all equipment and detailing required by local codes.



**Figure 13 - Water Heater with Air Handler without Internal or External Recirculation - NOTE: There is a Built-In Flow Check in the Internal Pump Loop**

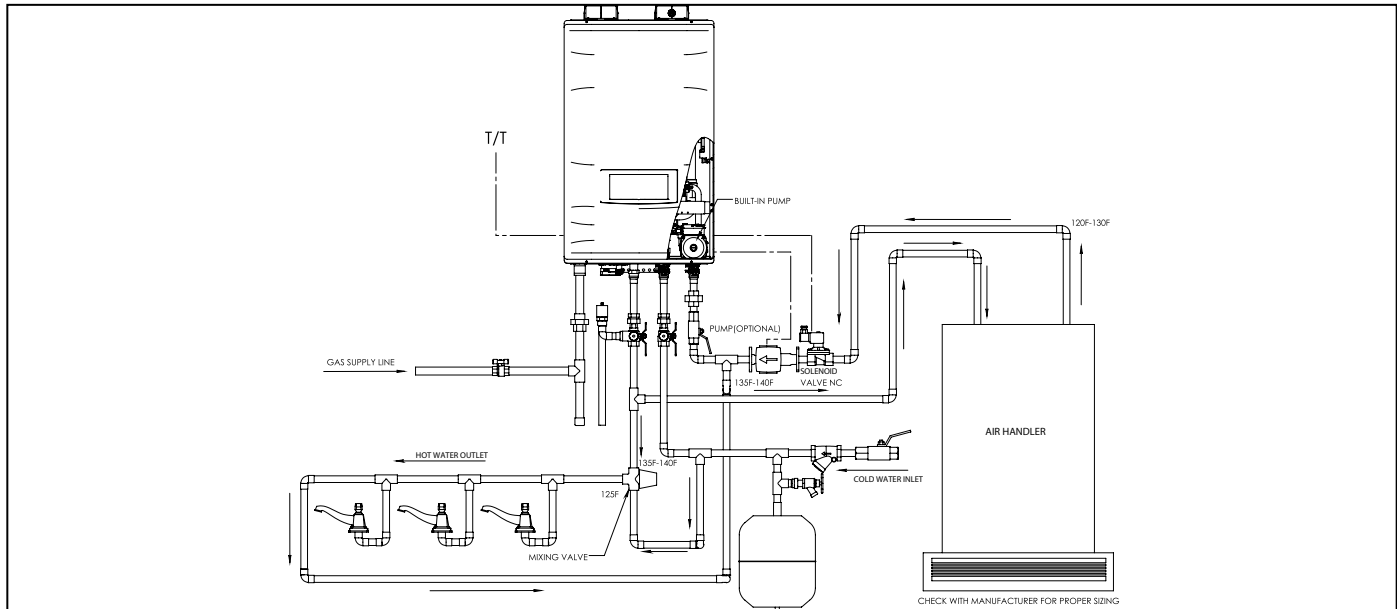

**Figure 14 - Water Heater with Air Handler and Recirculation - NOTE: There is a Built-In Flow Check in the Internal Recirculation Pump Loop**

**NOTE:** If Preheat, Internal, or External Recirculation is active when using Air Handler, a solenoid valve must be used to isolate air handler loop when central heating is not needed.

**NOTES:**

1. Minimum pipe size should match connection size. Upsize pipe accordingly if greater flow is required.
2. A thermal expansion tank suitable for potable water must be sized and installed within this piping system between the backflow preventer and the cold water inlet.
3. All circulators should have an integral flow check.
4. Drains and check valve between unit and storage tank will assist in purging air from system.
5. These drawings are meant to demonstrate system piping only. The installer is responsible for all equipment and detailing required by local codes. In Massachusetts, you must install a vacuum relief valve per 248 CMR.
6. Mixing valve application is optional, but recommended to help prevent scalding.
7. Always shut off power to the water heater or isolate the heater from the system if ANY plumbing work is to be done. Running the water heater without water will result in dry-firing.

**NOTES FOR AIR HANDLER APPLICATION:**

1. WHEN USING AN AIR HANDLER, IT IS REQUIRED TO SET THE WATER HEATER INSTALLER PARAMETER 19:SU to AH – AIR HANDLER MODE. THE RECIRCULATION PUMP WILL RUN ONCE EVERY 6 HOURS FOR 60 SECONDS TO SANITIZE WATER IN THE AIR HANDLER LOOP.
2. MASSACHUSETTS STATE PLUMBING CODE REQUIRES A DISTANCE NO GREATER THAN 50 FEET FROM THE WATER HEATER TO THE FAN COIL IN THE AIR HANDLER.
3. MASSACHUSETTS STATE PLUMBING CODE REQUIRES AN ELECTRONICALLY TIMED CIRCULATOR PUMP TO ACTIVATE EVERY SIX HOURS FOR 60 SECONDS. THIS CIRCULATOR IS REQUIRED TO BE BRONZE OR STAINLESS.
4. ALL WATER PIPING MUST BE INSULATED.
5. YOU MUST INSTALL A VACUUM RELIEF VALVE PER 248 CMR.

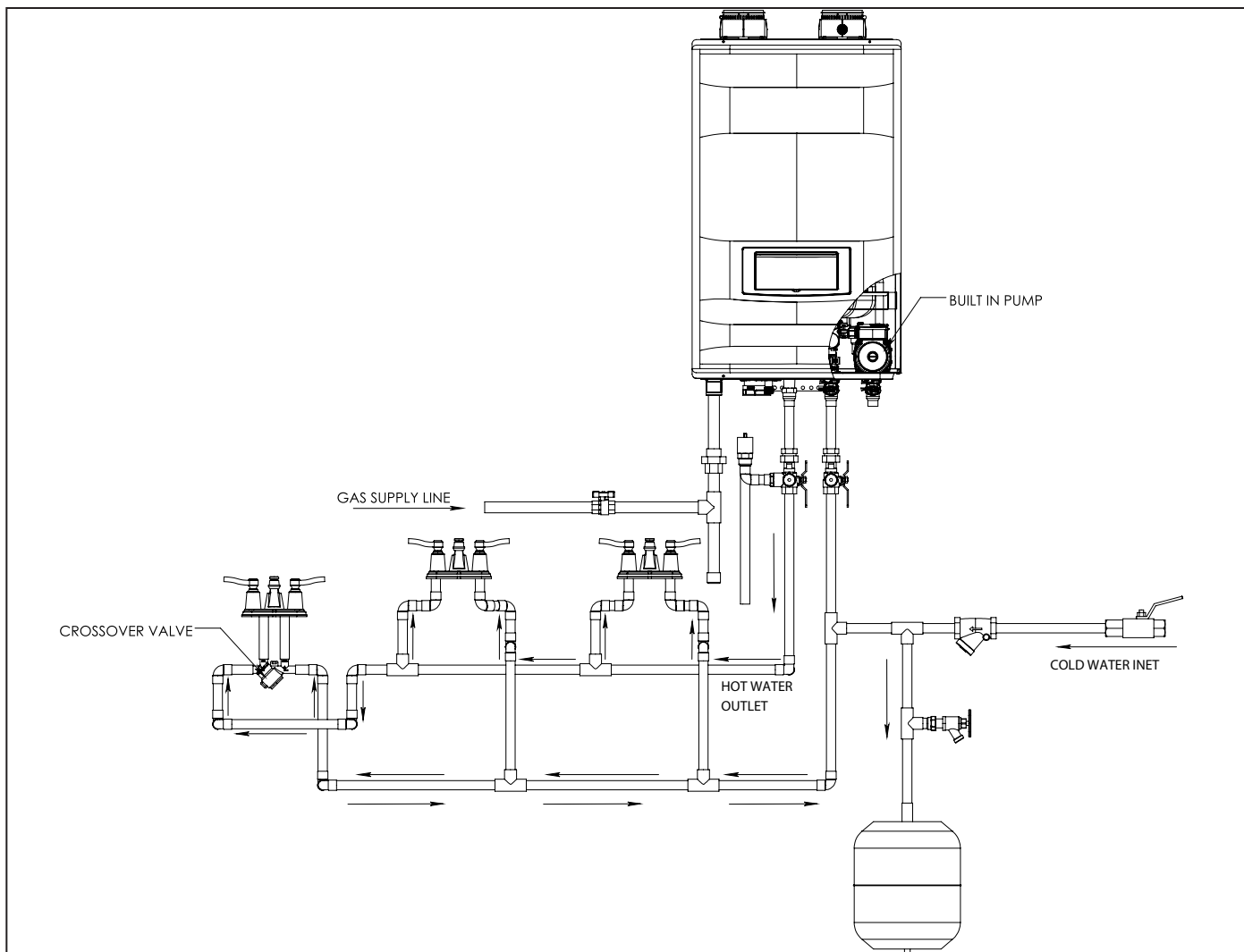

**NOTE:** THIS DRAWING IS MEANT TO DEMONSTRATE SYSTEM PIPING ONLY. THE INSTALLER IS RESPONSIBLE FOR ALL EQUIPMENT AND DETAILING REQUIRED BY LOCAL CODES.

**NOTE:** These drawings are meant to show system piping concept only. Installer is responsible for all equipment and detailing required by local codes.



**Figure 15 - Water Heater with Thermal Bypass Valve - NOTE: There is a Built-In Flow Check in the Internal Recirculation Pump Loop**  
**Using the Optional Crossover (Thermal Bypass) Valve**

In piping applications where a dedicated recirculation line is not available or too costly to install, the water heater can use a crossover (thermal bypass) valve as a method of recirculation. The water heater uses its Internal Recirculation Pump, internal bypass line, and a crossover valve installed between the hot and cold supply lines at the furthest fixture in the plumbing line from the water heater to temporarily use the cold water line to recirculate hot water through the system. A thermal bypass valve may be purchased at your local plumbing supplier. When using an optional Crossover (Thermal Bypass) Valve, the Internal Recirculation Pump circulates hot water through the system to the thermal bypass valve, where it is directed back to the water heater through the cold water line when hot water is not in use.

NOTE: When using an optional Crossover (Thermal Bypass) Valve, set the water heater Installer Parameter 0:RC to  - Preheat Mode, or  - Internal Recirculation Mode.

**PIPING NOTES:**

1. Minimum pipe size should match connection size. Upsize pipe accordingly if greater flow is required.
2. A thermal expansion tank suitable for potable water must be sized and installed within this piping system between the backflow preventer and the cold water inlet.
3. All circulators should have an integral flow check.
4. Drains and check valve between unit and storage tank will assist in purging air from system.
5. These drawings are meant to demonstrate system piping only. The installer is responsible for all equipment and detailing required by local codes. In Massachusetts, you must install a vacuum relief valve per 248 CMR.
6. Mixing valve application is optional, but recommended to help prevent scalding.
7. Always shut off power to the water heater or isolate the heater from the system if ANY plumbing work is to be done. Running the water heater without water will result in dry-firing.

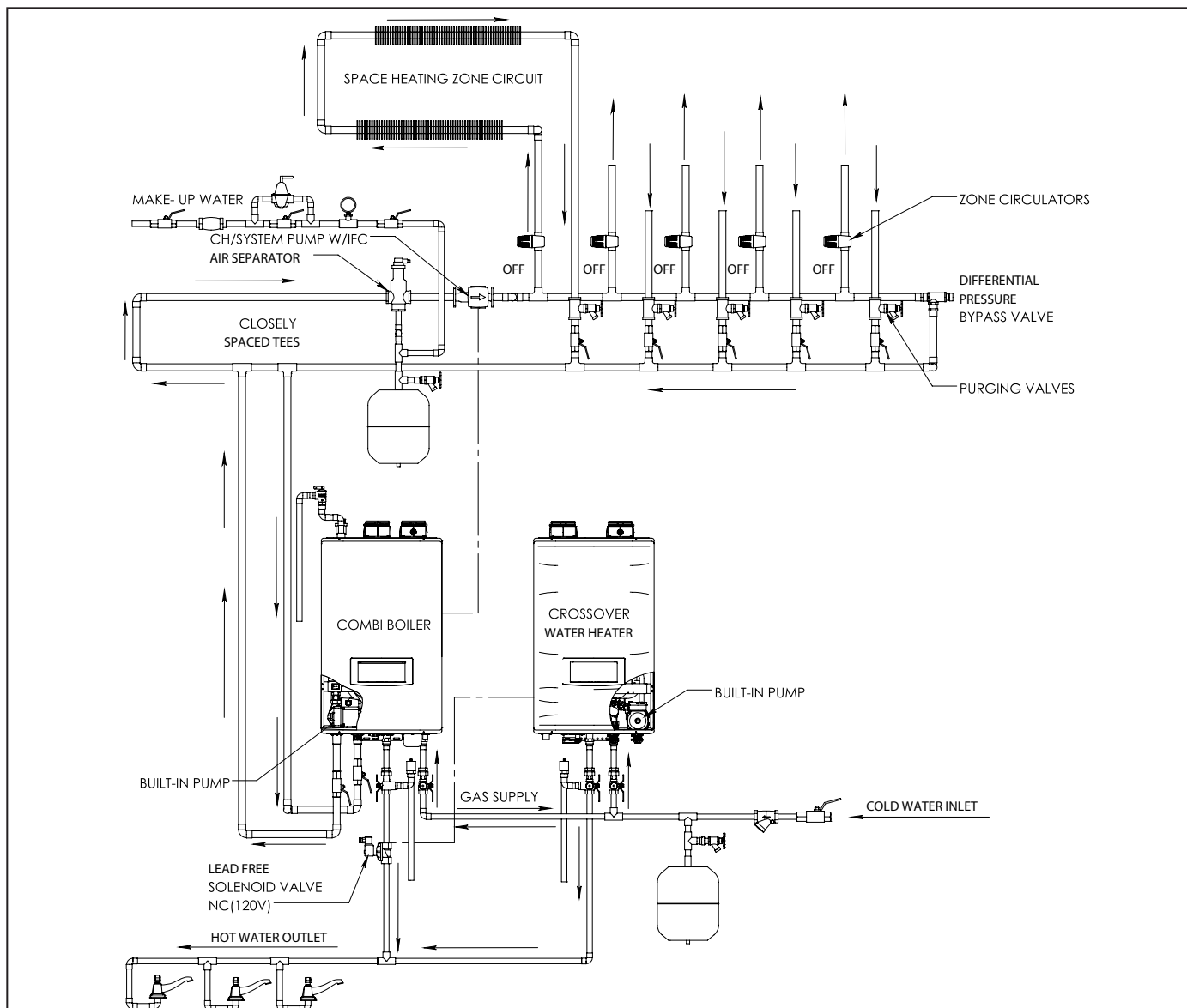

**Figure 16 - Water Heater Installed with Combi Appliance - NOTE: There is a Built-In Flow Check in the Internal Recirculation Pump Loop**

**NOTE:** The solenoid valve is powered by the water heater. The solenoid valve must be normally closed, energize when the water heater is over 90% of capacity, and deactivate when water heater is less than 50% of capacity.

**NOTE:** When a water heater is installed with a combi appliance, ensure Installer Parameter 19:SU is set to Cd – Comfort Mode. This is the default mode of operation. Also wire the solenoid as described in Figure 16. Failure to do so will result in improper appliance operation.

**NOTE:** Ensure the DHW temperature setting is the same on the water heater and the combi appliance. Failure to do so will result in improper appliance operation.

**NOTES:**

1. Minimum pipe size should match connection size. Upsize pipe accordingly if greater flow is required.
2. A thermal expansion tank suitable for potable water must be sized and installed within this piping system between the backflow preventer and the cold water inlet.
3. All circulators should have an integral flow check.
4. Drains and check valve between water heater and piping will assist in purging air from system.
5. These drawings are meant to demonstrate system piping only. The installer is responsible for all equipment and detailing required by local codes. In Massachusetts, you must install a vacuum relief valve per 248 CMR.
6. Mixing valve application is optional, but recommended to help prevent scalding.
7. Always shut off power to the water heater or isolate the heater from the system if ANY plumbing work is to be done. Running the water heater without water will result in dry-firing.

**NOTE:** These drawings are meant to show system piping concept only. Installer is responsible for all equipment and detailing required by local codes.



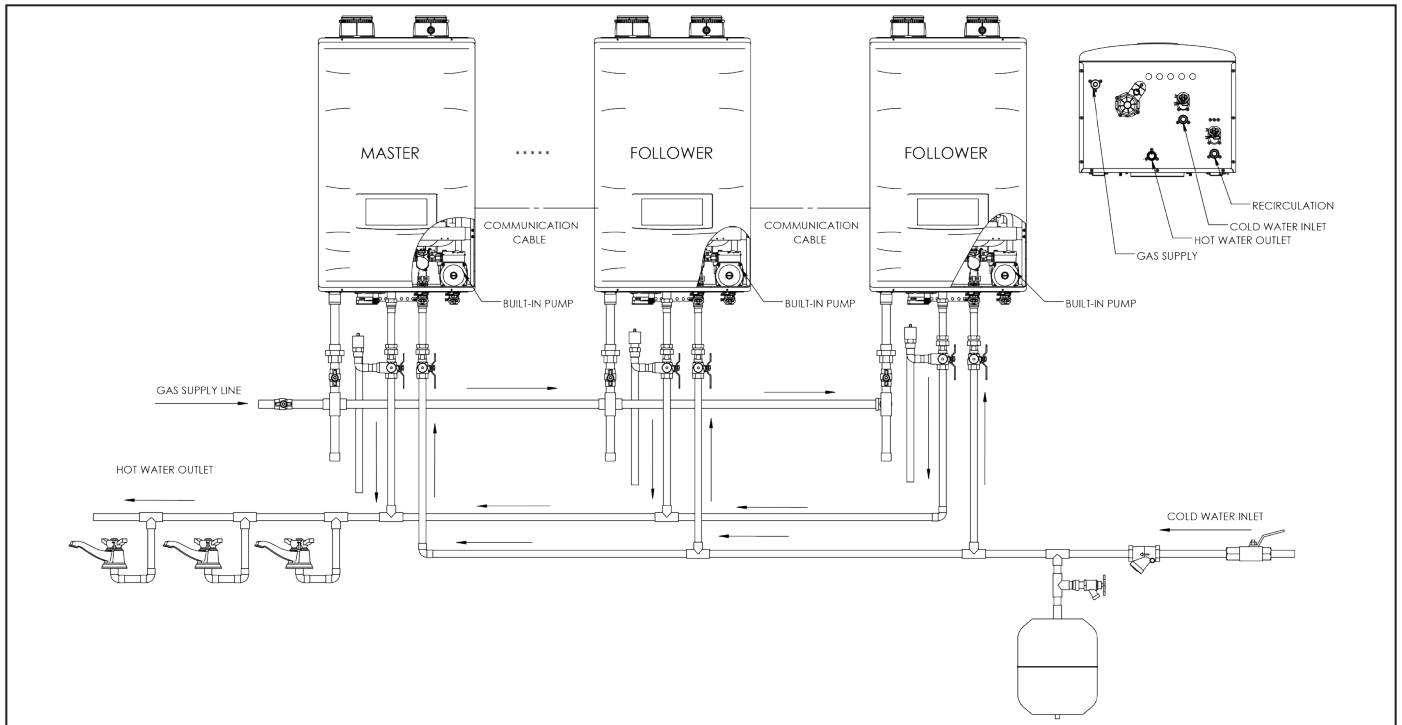

**Figure 17 - Cascaded Water Heaters**

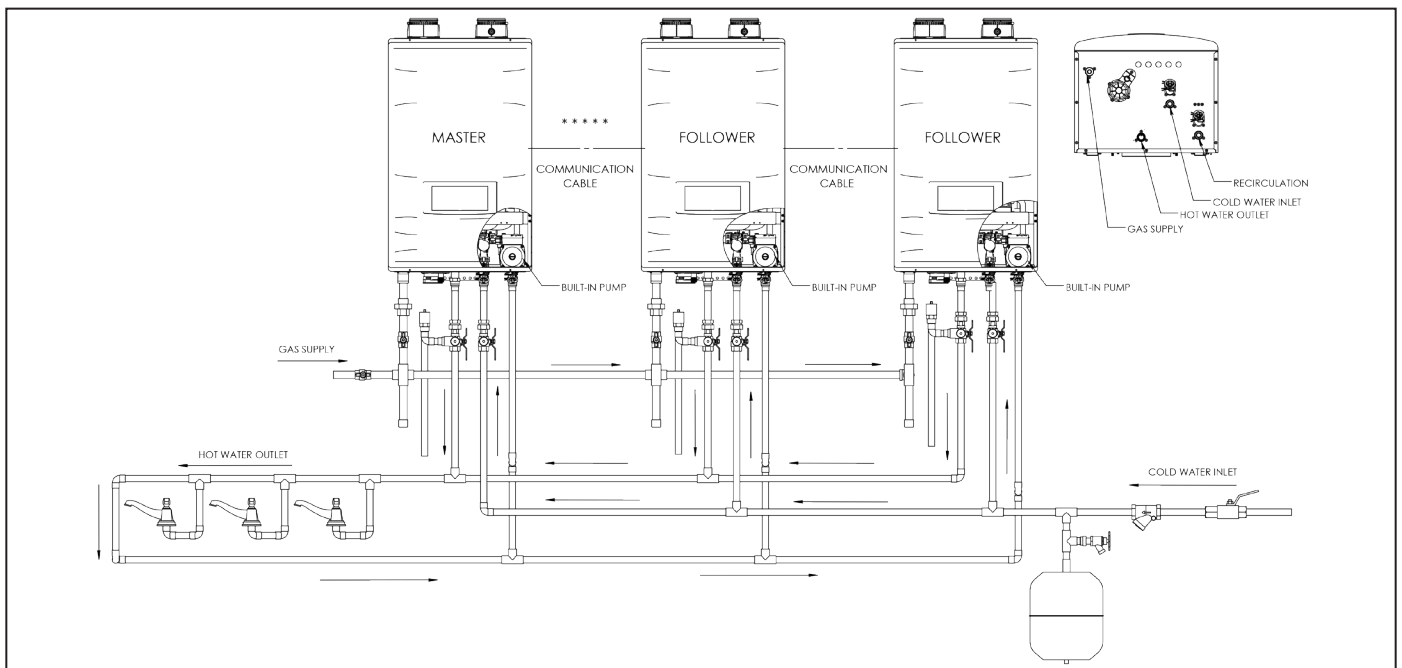

**Figure 18 - Cascaded Water Heaters w/ Recirculation**

**NOTE:** For installations where internal pump is not adequate for the recirculation loop, an additional pump can be installed and powered by the appliance (2A Max). See Pressure Drop and Pump Curves, this manual.

**NOTES:**

1. Minimum pipe size should match connection size. Upsize pipe accordingly if greater flow is required.
2. A thermal expansion tank suitable for potable water must be sized and installed within this piping system between the backflow preventer and the cold water inlet.
3. All circulators should have an integral flow check.
4. Drains and check valve between water heater and piping will assist in purging air from system.
5. These drawings are meant to demonstrate system piping only. The installer is responsible for all equipment and detailing required by local codes. In Massachusetts, you must install a vacuum relief valve per 248 CMR.
6. Mixing valve application is optional, but recommended to help prevent scalding.
7. Always shut off power to the water heater or isolate the heater from the system if ANY plumbing work is to be done. Running the water heater without water will result in dry-firing.

**NOTE:** These drawings are meant to show system piping concept only. Installer is responsible for all equipment and detailing required by local codes.

## F. Circulator Sizing

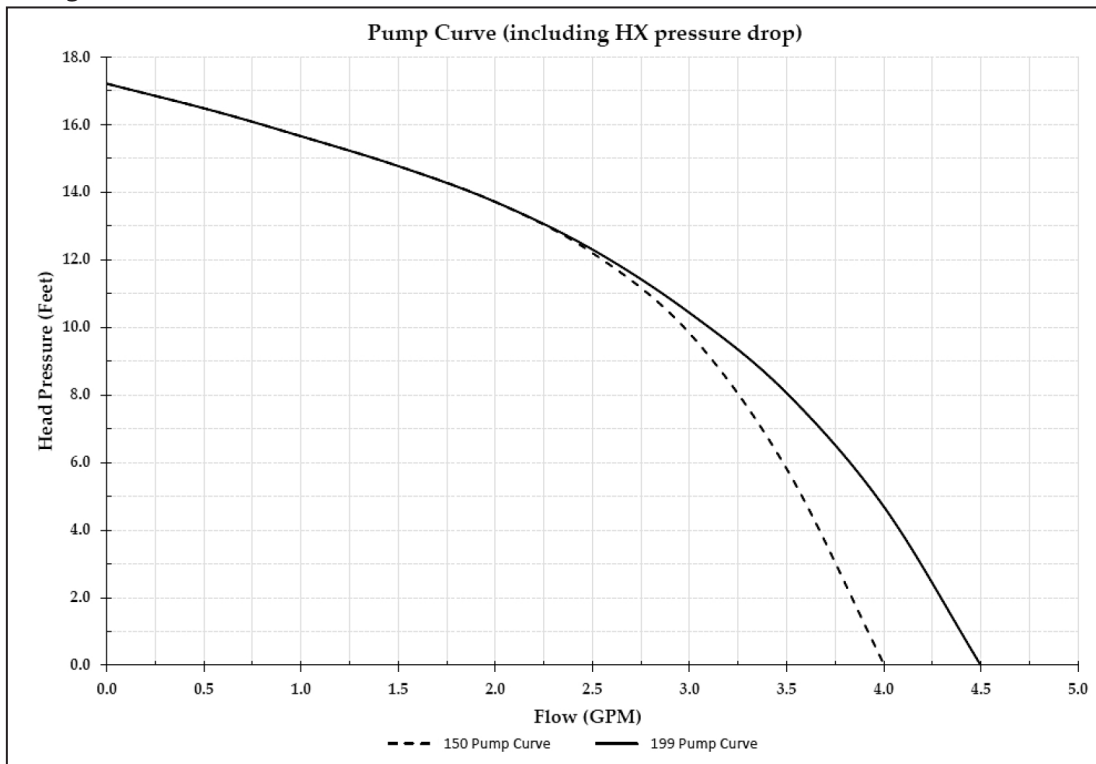

Figure 19 - This chart represents the internal recirculation pump performance curve taking into account valves and heat exchanger pressure losses.

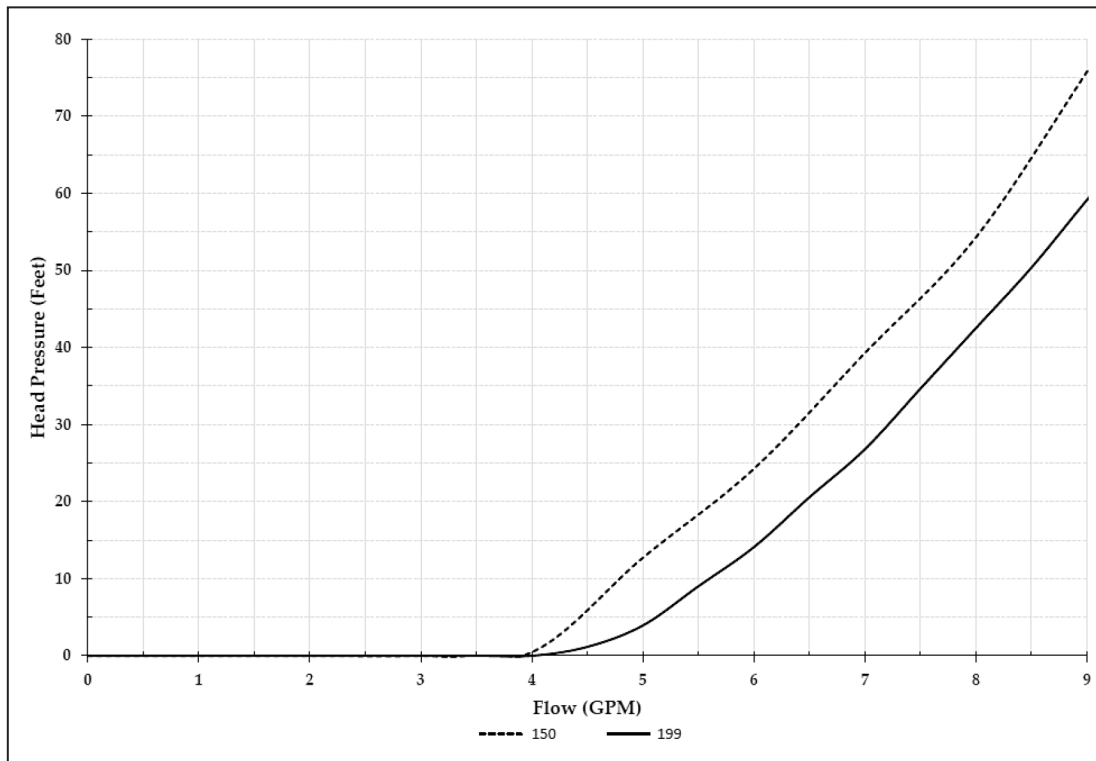

Figure 20 - This chart represents heat exchanger pressure drop through the heat exchanger and internal valves.

**NOTE:** When using external recirculation mode with the built-in pump, observe the following maximum recirculation pipe lengths including fittings:

- 1/2" Copper Pipe- 200 ft (60 m) of equivalent pipe length
- 3/4" Copper Pipe- 500 ft (167 m) of equivalent pipe length.

Lengths in excess of these limits will require an external recirculation pump. See pressure drop curve to size pump accordingly.

Use Function 16:so in the Installer Menu to widen the Delta-T to avoid short cycling if recirculation line is not insulated.

Number of Units	$\Delta T = 77^{\circ}\text{F}$			$\Delta T = 45^{\circ}\text{F}$			$\Delta T = 35^{\circ}\text{F}$		
	Flow Rate (GPM)	Water Velocity (ft/s)	Pipe Dia. (In.)	Flow Rate (GPM)	Water Velocity (ft/s)	Pipe Dia. (In.)	Flow Rate (GPM)	Water Velocity (ft/s)	Pipe Dia. (In.)
1	5	3.75	3/4	9	3.61	1	11	4.64	1
2	10	4.22	1	18	3.21	1 1/2	23	4.13	1 1/2
3	16	4.05	1 1/4	27	4.82		2	34	3.48
4	21	3.75	1 1/2	35	3.61	2 1/2		45	4.64
5	26	4.69		44	4.52		3	57	3.72
6	31	3.17	2	53	3.47	3 1/2		68	4.46
7	36	3.69		62	4.05		4	80	3.61
8	41	4.22	71	4.62	4 1/2	91		4.13	4 1/2
9	47	4.75	80	3.61		5	102	4.64	
10	52	3.38	2 1/2	88	4.01		5 1/2	114	3.79
11	57	3.72		97	4.42	6		125	4.17
12	62	4.05	106	4.82	6 1/2		136	4.55	6 1/2
13	67	4.39	3	115		3.83	7	148	
14	72	4.73		124	4.13	7 1/2		159	4.06
15	78	3.52	3 1/2	133	4.42		8	171	4.35
16	83	3.75		142	4.72	8 1/2		182	4.64
17	88	3.99	3	150	3.84		9	193	4.94
18	93	4.22		159	4.06	4		205	5.23

**Table 11 - Recommended Water Pipe Size NOTE:** The above pipe sizes are recommended based on water velocity of 5 ft/s and a maximum water temperature of 140°F.

### G. Pressure Relief Valve

An external pressure relief valve must be installed on this water heater. When installing, observe the following guidelines. Failure to comply with these guidelines can result in substantial property damage, personal injury, or death.

This water heater must be provided with an approved 150 psi, 3/4" ASME HV Valve that must be installed on the DHW outlet line. The 150 psi Pressure Relief Valve must be installed on the DHW outlet line to ensure a compliant installation and safe operation.

This water heater has a high-temperature shut-off switch built in as a standard safety feature. Therefore, a "pressure only" relief valve is required. DO NOT operate this water heater before the supplied pressure relief valve is installed with sufficient relieving capacity in accordance with the rating plate on the water heater.

Pressure relief valves must be installed as close to the water heater as possible. No other valves should be placed between the pressure relief valve and the appliance. DO NOT install a relief valve with a pressure rating greater than 150 psi. This is the maximum allowable relief valve setting for this water heater.

After installing the relief valve and filling and pressurizing the system, test the operation of the valve by lifting the lever. Make sure the valve discharges freely. If the valve fails to operate correctly, replace it with a new relief valve. Ensure that the maximum BTU/H rating on the pressure relief valve is equal to or greater than the maximum input BTU/H rating of the combination water heater.

## WARNING

To avoid water damage or scalding due to relief valve operation:

- Discharge line must be connected to relief valve outlet and run to a safe place of disposal. Terminate the discharge line in a manner that will prevent possibility of severe burns or property damage should the relief valve discharge.
- Discharge line must be as short as possible and the same size as the valve discharge connection throughout its entire length.
- Discharge line must pitch downward from the valve and terminate at least 6" above the floor drain, making discharge clearly visible.
- Discharge line shall terminate plain, not threaded, with a material serviceable for temperatures of 375°F or greater.
- Do not pipe discharge to any location where freezing could occur.
- No shutoff valve may be installed between the relief valve and water heater or in the discharge line. Do not plug or place any obstruction in the discharge line.
- Test the operation of the relief valve after filling and pressurizing the system by lifting the lever. Make sure the valve discharges freely. If the valve fails to operate correctly, replace it with a new relief valve.
- Test relief valve at least once annually to ensure the waterway is clear. If valve does not operate, turn the water heater "off" **and call a plumber immediately.**
- Take care whenever operating relief valve to avoid scalding injury or property damage.
- For water heaters installed with only a pressure relief valve, the separate storage vessel must have a temperature and pressure relief valve installed. This relief valve shall comply with Relief Valves for Hot Water Supply Systems, ANSI Z21.22 CSA4.4.

**FAILURE TO COMPLY WITH THE ABOVE GUIDELINES COULD RESULT IN FAILURE OF RELIEF VALVE OPERATION, RESULTING IN POSSIBILITY OF SUBSTANTIAL PROPERTY DAMAGE, SEVERE PERSONAL INJURY, OR DEATH.**

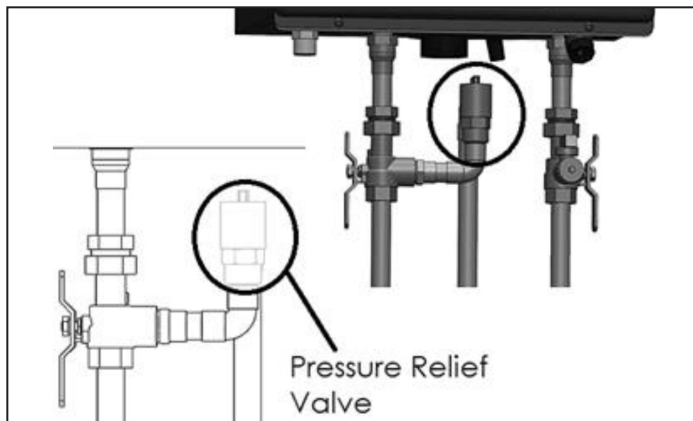

Figure 21 - Relief Valve Details

## WARNING

Do not thread a cap or plug into the relief valve or relief valve line under any circumstances! Explosion and property damage, serious injury, or death may result.

**RE-INSPECTION OF RELIEF VALVES: Valves should be inspected AT LEAST ONCE EVERY THREE YEARS, and replaced if necessary,** by a licensed plumbing contractor or qualified service technician to ensure that the product has not been affected by corrosive water conditions and to ensure that the valve and discharge line have not been altered or tampered with illegally. Certain naturally occurring conditions may corrode the valve and its components over time, rendering the valve inoperative. Such conditions can only be detected if the valve and its components are physically removed and inspected. **Do not attempt to conduct an inspection on your own.** Contact your plumbing contractor for a re-inspection to assure continued safety.

**FAILURE TO RE-INSPECT THE RELIEF VALVE AS DIRECTED COULD RESULT IN UNSAFE TEMPERATURE AND/OR PRESSURE BUILD-UP WHICH CAN RESULT IN PROPERTY DAMAGE, SERIOUS PERSONAL INJURY, OR DEATH.**

## H. Filling the Heater

### WARNING

The water heater must be full of water and the system fully purged BEFORE powering the water heater. When filling the water heater, open a hot water tap to release air in the water heater and piping. All air has been purged from the system when water runs freely from the faucets.

Applying power to the water heater when it is not full of water will damage the heat exchanger, and could result in property damage, serious personal injury, or death. Such damages ARE NOT covered by water heater warranty.

- Ensure any drain valves are completely closed.
- Open the shut-off valve in the cold water supply line.
- Open the hot water faucets to allow air to vent from the heater and piping.
- Allow sufficient time for the heater to completely fill with water.

## Part 5 - Venting

### ⚠ DANGER

The heater must be vented as detailed in this section. Ensure exhaust vent and intake piping complies with these instructions regarding vent system. Inspect finished exhaust vent and intake piping thoroughly to ensure all joints are well secured, airtight, and comply with all applicable code requirements, as well as the instructions provided in this manual. Failure to properly install the vent system will result in severe personal injury or death.

### A. General

### ⚠ DANGER

This heater is certified as a "Category IV" appliance and requires a special venting system. The vent system will operate with a positive pressure in the pipe. Exhaust gases must be piped directly outdoors using the vent materials and rules outlined in these instructions. Do not connect vent connectors serving appliances vented by natural draft into any portion of mechanical draft systems operating under positive pressure. Follow the venting instructions carefully. Failure to do so will result in substantial property damage, severe personal injury, or death.

Exhaust and intake are to be piped separately. This heater cannot share a common exhaust or intake with multiple appliances. Failure to follow these instructions will result in substantial property damage, severe personal injury, or death.

1. Installation should be made in accordance with the regulations of the Authority Having Jurisdiction, local code authorities, and utility companies which pertain to this type of water heating equipment.
2. Install the venting system in accordance with these instructions and with the National Fuel Gas Code, ANSI Z223.1/NFPA 54, CAN/CGA B149, and / or applicable provisions of local building codes.
3. This water heater must be vented with materials, components, and systems listed and approved for Category IV appliances.

**NOTE:** To avoid contamination often contained in indoor air, it is best to pipe all intake combustion air directly to the outdoors.

**NOTE:** Care must be taken to prevent condensate freezing in the exhaust vent pipe system. See local, state, provincial, and national codes for best practices to prevent condensate freezing in the exhaust vent pipe system.

### ⚠ WARNING

- DO NOT insulate the first three (3) linear feet of the exhaust vent run.

- CPVC, Polypropylene, or Stainless Steel pipe material MUST be used if the first three (3) linear feet of the exhaust vent run is insulated or passes through an enclosed space greater than 6" in length, such as a wall. **NOTE:** Only Stainless Steel pipe material may be insulated.

- If CPVC is used to meet these requirements, the balance may be installed with approved PVC pipe.

- If Polypropylene or Stainless Steel is used to meet these requirements, the balance of the vent run must be installed with the same material.

- Failure to comply with this warning could result in property damage, severe personal injury, or death.

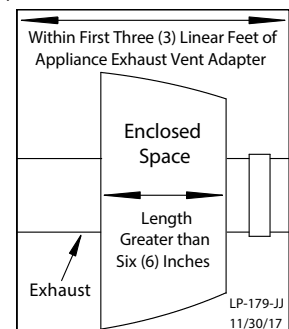

## ! DANGER

Due to the extreme flammability of most glues, cements, solvents, and primers used to join plastic exhaust vent and intake pipes, explosive solvent vapors must be cleared from all vent piping before start-up. Avoid using excess cement or primer, as this may pool in the vent pipes. Vent assemblies should be allowed to cure for a period of at least 8 hours before powering a connected appliance. Failure to follow these instructions will result in substantial property damage, severe personal injury, or death. It is the installers' responsibility to understand the hazards associated with explosive solvents and take the necessary precautions to avoid these risks.

## ! WARNING

Exhaust vent adaptors are not designed as load-bearing devices, and must not be used to support exhaust vent piping. All vent pipes must be properly connected, supported, and the exhaust vent must be pitched a minimum of 1/4" per foot back to the heater to allow drainage of condensate. Failure to properly support vent piping and follow the information in this statement could result in product damage, severe personal injury, or death.

Improper seating of vent pipe gaskets can cause eventual gasket failure and exhaust gas leakage. Ensure the exhaust vent pipe is properly beveled and seated before insertion into the flue adapter. Failure to do so could result in property damage, severe personal injury, or death.

### B. Approved Materials for Exhaust Vent and Intake Pipe

Item	Material	Standards for Installation In:	
		United States	Canada
<b>Pipe and Fittings Approved for Intake ONLY</b>	ABS*	ANSI/ASTM D2661	ANSI/ASTM D2661
<b>Pipe Approved for Intake OR Exhaust Vent</b>	PVC Schedule 40/80	UL-1738 or ANSI/ASTM D1785	UL-1738 or ULC-S636
	PVC-DWV Schedule 40/80	UL-1738 or ANSI/ASTM D2665	
	CPVC Schedule 40/80	UL-1738 or ANSI/ASTM F441	
	Polypropylene	UL-1738 or ULC-S636	
	Stainless Steel AL29-4C	Certified for Category IV and Direct Vent Appliance Venting	
<b>Pipe Fittings</b>	PVC Schedule 40	UL-1738, ANSI/ASTM D2466 or D2665	UL-1738 or ULC-S636
	PVC Schedule 80	UL-1738, ANSI/ASTM D2467 or D2665	
	CPVC Schedule 40	UL-1738 or ANSI/ASTM F438	
	CPVC Schedule 80	UL-1738 or ANSI/ASTM F439	
<b>Pipe Cement</b>	ABS*	ANSI/ASTM D2235	IPEX System 636 Cements and Primers
	PVC	ANSI/ASTM D2564	
	CPVC	ANSI/ASTM F493	
<b>Pipe Primer</b>	PVC / CPVC	ASTM F656	

## ! DANGER

- The exhaust and intake components installed with this appliance must be used for near appliance piping BEFORE transitioning to the approved materials listed above. DO NOT REMOVE these installed components. Doing so WILL VOID appliance warranty.
- PVC / CPVC pipe and fittings of the same diameter are considered interchangeable.
- The use of cellular core PVC (ASTM F891), cellular core CPVC, or Radel® (polyphenolsulfone) in non-metallic venting systems is prohibited.
- Covering non-metallic vent pipe and fittings with thermal insulation is prohibited.
- DO NOT connect PVC/CPVC to Polypropylene without an approved vent connector.
- Any transition to Polypropylene MUST be done in the vertical within five (5) feet of the appliance.
- When installing AL29-4C vent piping, install a PVC-to-stainless adapter at the appliance vent connection, and at the termination when using a PVC termination kit. DO NOT mix AL29-4C piping from different manufacturers unless using adapters specifically designed for the purpose by the manufacturer.
- A double wall vent or insulated material may be used when using stainless steel vent material in a freezing climate.
- \*ABS may be used for air intake applications ONLY. ABS is NOT PERMITTED for use in Canada.
- Contact the venting material manufacturer if there is any question about the applicability of the proposed venting material.

Failure to follow these directions will result in substantial property damage, severe personal injury, or death.

**Table 12 - Approved Materials for Exhaust Vent and Intake Pipe**



## ⚠ WARNING

DO NOT mix components from different venting systems. The vent system could fail, causing leakage of flue products into the living space. Use only the approved pipe and fitting materials, and primer and cement specifically designed for the material used, as listed in the above table. Failure to do so could result in property damage, serious injury, or death.

## CAUTION

High heat sources (generating heat 100°F / 37°C or greater, such as boiler flue pipes, space heaters, etc.) may damage plastic components of the water heater as well as plastic vent pipe materials. Such damages ARE NOT covered by warranty. It is recommended to keep a minimum clearance of 8" from high heat sources. Observe heat source manufacturer instructions, as well as local, state, provincial, and national codes, laws, regulations, and ordinances when installing this water heater and related components near high heat sources.

**NOTE:** The use of double-wall vent or insulated material for the combustion air intake pipe is recommended in cold climates to prevent the condensation of airborne moisture in the incoming combustion air.

## ⚠ WARNING

It is required to insert the provided exhaust and intake screens into the vent terminations to prevent blockage caused by debris or birds. Failure to keep terminations clear could result in property damage, severe personal injury, or death.

## ⚠ DANGER

You must not use "B" vent in an exhaust application. "B" vent is for intake applications ONLY. Using "B" vent in an exhaust application will result in serious injury or death.

### C. Additional Requirements for Installation in Canada

1. Installations must be made with a vent pipe system certified to ULC-S636. IPEX is an approved vent manufacturer in Canada supplying vent material listed to ULC-S636. Additionally, you may use AL29-4C stainless steel venting to comply with Canadian requirements.
2. The first three (3) feet of vent pipe from the water heater flue outlet must be readily accessible for visual inspection.
3. The components of the certified vent system must not be interchanged with other vent systems or unlisted pipe / fittings.

## ⚠ WARNING

### Breathing Hazard - Carbon Monoxide Gas

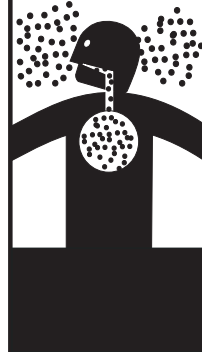

- Do not operate heater if flood damaged.
- Install vent system in accordance with local codes and manufacturers installation instructions.
- Do not obstruct heater air intake or exhaust. Support all vent piping per manufacturers installation instructions.
- Do not place chemical vapor emitting products near unit.
- According to NFPA 720, carbon monoxide detectors should be installed outside each sleeping area.
- Never operate the heater unless it is vented to the outdoors.
- Analyze the entire vent system to make sure that condensate will not become trapped in a section of vent pipe and therefore reduce the open cross sectional area of the vent.

**Breathing carbon monoxide can cause brain damage or death. Always read and understand instruction manual.**

LP-304

**D. Exhaust Vent and Intake Pipe Location**

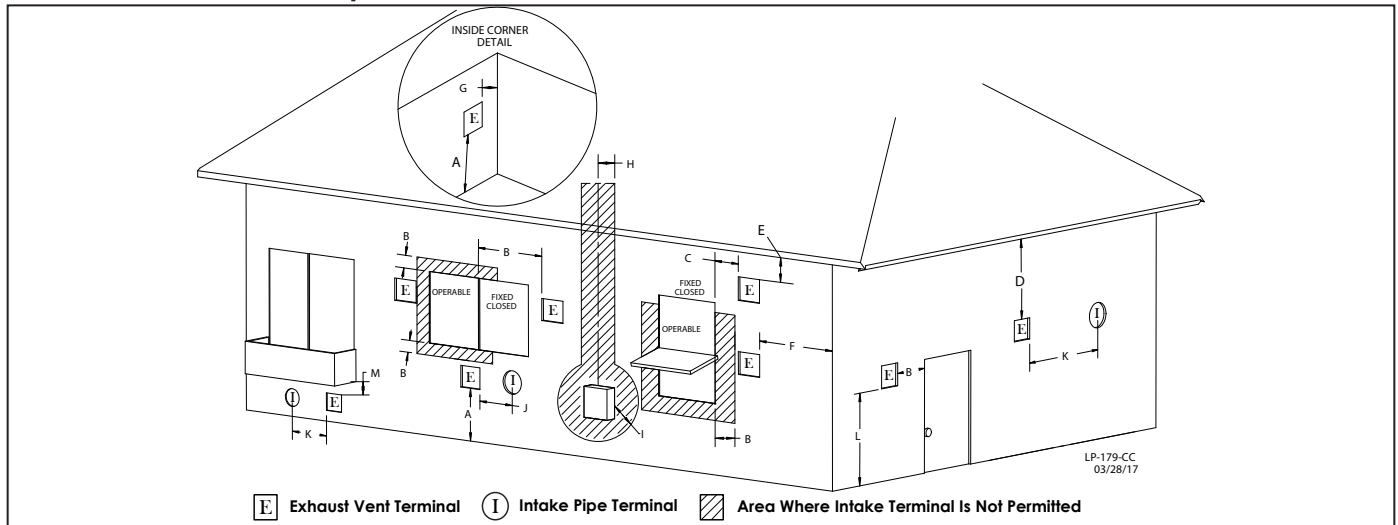

**Figure 22 - Exit Terminals for Direct Vent Systems - ANSI Z223.1 / NFPA 54 for US and CAN/CSA B149.1 for Canada**

DESCRIPTION		US	CANADA
<b>A</b>	Clearance above grade, veranda, porch, deck, or balcony	1 foot (30 cm)	
<b>B</b>	Clearance to window or door that may be opened	Direct Vent	1 foot
		Power Vent	4 ft below or to side of opening; 1 ft above opening
<b>C</b>	Clearance to permanently closed window	*	
<b>D</b>	Vertical clearance to ventilated soffit located above the terminal within a horizontal distance 2 feet (61 cm) from the center line of the terminal	*	
<b>E</b>	Clearance to unventilated soffit	*	
<b>F</b>	Clearance to outside corner	*	
<b>G</b>	Clearance to inside corner	*	
<b>H</b>	Clearance to each side of center line extended above meter / regulator assembly	*	
<b>I</b>	Clearance to service regulator vent outlet	*	Above a regulator within 3 feet (91 cm) horizontally of the vertical center line of the regulator vent outlet to a maximum vertical distance of 15 ft (4.5 m)
<b>J</b>	Clearance to nonmechanical air supply inlet to building or the combustion air inlet to any other appliance	Direct Vent	1 foot
		Power Vent	4 ft below or to side of opening; 1 ft above opening
<b>K</b>	Clearance to mechanical air supply inlet	3 feet above if within 10 feet horizontally	6 feet (1.83 m)
<b>L</b>	Clearance above paved sidewalk or paved driveway located on public property	Direct Vent	*
		Power Vent	7 feet (2.13 m)
<b>M</b>	Clearance under veranda, porch deck, or balcony	1 foot (30 cm)	

**Table 13 - Vent Termination Clearances - \*NOTE: For clearances not specified in ANSI Z223.1 / NFPA 54 for US and CAN/CSA B149.1 for Canada, please use clearances in accordance with local installation codes and the requirements of the gas supplier.**

**⚠ WARNING**

The building owner is responsible for keeping the exhaust and intake terminations free of snow, ice, or other potential blockages, as well as scheduling routing maintenance. Failure to keep the vent piping terminations clear and properly maintain the heater could result in property damage, severe personal injury, or death.

For each floor containing bedroom(s), a carbon monoxide detector and alarm shall be placed in the living area outside the bedrooms, as well as in the room that houses the heater. Detectors and alarms shall comply with NFPA 720 (latest edition). Failure to comply with these requirements could result in product damage, severe personal injury, or death.

**E. Exhaust Vent and Intake Pipe Sizing**

1. The exhaust vent and intake pipe size is 3".
2. The total equivalent length of 2" exhaust vent and intake pipe **should not exceed fifty (50) feet**; 3" exhaust vent and intake pipe **should not exceed one hundred (100) feet**.
  - a. The equivalent length of elbows, tees, and other fittings are listed in the Friction Loss Table.
  - b. For example: If the exhaust vent has two 90° elbows and 10 feet of PVC pipe we will calculate:  
 Exhaust Vent Equivalent Length = (2x5) + 10 = 20 feet.  
 Further, if the intake pipe has two 90° elbows, one 45° elbow, and 10 feet of PVC pipe, the following calculation applies:  
 Intake Pipe Equivalent Length = (2x5) + 3 + 10 = 23 feet.  
 Finally, if a concentric kit is used we find:  
 Total Equivalent Length = 20 + 23 + 3 = 46 feet.  
 The total equivalent length is 46 feet, well below the maximum of 100 feet.
  - c. Effort should be made to keep a minimum difference in equivalent length between the exhaust vent and intake pipe.

Friction Loss Equivalent in Piping and Fittings		
Fittings or Piping	Equivalent Feet	
	2"	3"
90 Degree Elbow*	5'	5'
45 Degree Elbow	3'	3'
Coupling	0'	0'
Air Inlet Tee	0'	0'
Straight Pipe	1'	1'
Concentric Kit	3'	3'
V500 2" Kit	1'	N/A
V1000 3" Kit	N/A	1'
V2000 4" Kit	N/A	1'

Table 14 - \*Friction loss for long radius elbow is 1 foot less. NOTE: Consult Polypropylene venting instructions for friction loss and pressure drop equivalents.

3. The minimum total equivalent length is 14 feet.  
**NOTE:** The intake pipe and exhaust vent lengths do not have to be of equal length. There is no balancing requirement between intake and exhaust.

2" Combined Vent Length		3" Combined Vent Length	
Minimum	Maximum	Minimum	Maximum
14' (4.2M)	50' (50M)	14' (4.2M)	100' (30M)
<b>Maximum # of 90° Elbows (2" and 3" Vent Diameters)</b>			
6			

Table 15 - Approved Vent Lengths

CAUTION

Do not exceed the maximum lengths for vent pipes. Excessive length could result in heater shutdown and property damage.

Failure to provide a minimum total vent length of 14 equivalent feet could result in property damage and improper product operation.

**F. Tightening Water Heater Collar to Exhaust Vent and Intake Pipe**

This appliance uses 2" or 3" diameter pipe for exhaust vent and intake pipe. In order to use 2" pipe, it is required to reduce pipe size in a vertical length of pipe with a 3" x 2" reducing coupling (not included). Follow the steps below to install 3" vent pipe into the appliance vent collar. See Figure 23 for additional details.

**NOTE:** Clean and dry the appliance connection. DO NOT use primer or cement on the appliance connection.

1. Push the length of pipe into the connection until it touches the bottom of the fitting.
2. Tighten the clamps using a screwdriver.
3. Ensure the pipe is secure before continuing installation.
4. For 2" installations, install the reducing coupling in a vertical section of pipe. At least a 6" length of 3" pipe **MUST BE INSTALLED** before reducing to 2". See Figure 24.

**NOTE:** A reducing coupling **MUST BE USED** when transitioning from 3" to 2" vent pipe. DO NOT use reducing bushings.

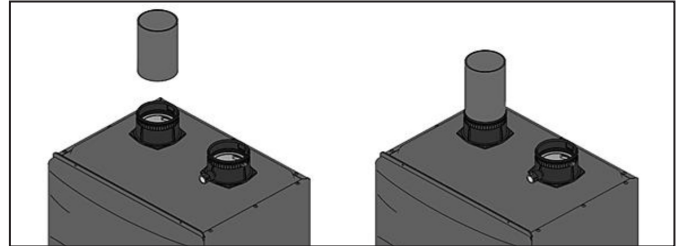

Figure 23 - Correct Installation into the Appliance Collar

**NOTE: REDUCING VENT SIZE: TRANSITIONING FROM 3" TO 2" VENT PIPE MUST ALWAYS TAKE PLACE IN A VERTICAL POSITION TO PREVENT CONDENSATE BLOCKAGE**

Figure 24 - Transitioning from 3" to 2" Vent Pipe

**G. Exhaust Vent and Intake Pipe Installation**

WARNING

All joints of positive pressure vent systems must be sealed completely to prevent leakage of flue products into the living space. Failure to do so could result in property damage, serious injury, or death.

1. Use only solid PVC, CPVC, or stainless steel pipe or a Polypropylene vent system approved for use with Category IV appliances. ABS pipe material may be used on air intake piping **only**.
2. Remove all burrs and debris from joints and fittings.
3. When using PVC or CPVC pipe, all joints must be properly cleaned, primed, and cemented. Use only cement and primer approved for use with the pipe material. Cement must conform to ASTM D2564 for PVC and ASTM F493 for CPVC pipe. **NOTE: DO NOT CEMENT POLYPROPYLENE PIPE.**
4. Ensure the vent is located where it will not be exposed to prevailing winds.
5. In all roof venting applications, exhaust discharge must point away from the pitch of the roof.
6. To prevent water leakage, install adequate roof flashing where the pipe enters the roof.
7. Do not locate vent over public walkways, driveways, or parking lots. Condensate could drip and freeze, resulting in a slip hazard or damage to vehicles and machinery.
8. Due to potential moisture build-up, sidewall venting may not be the preferred venting option. To save time and cost, carefully consider venting installation and location.
9. Horizontal lengths of exhaust vent must slope back towards the water heater not less than 1/4" per foot to allow condensate to drain from the vent pipe.
10. The exhaust vent must terminate where vapors cannot make accidental contact with people or pets, or damage shrubs or plants.
11. In vacant chimney applications, install and seal a rain cap over existing chimney openings.

- 12. All piping must be fully supported. Use pipe hangers at a minimum of 4 foot intervals to prevent sagging of the pipe where condensate may form.
- 13. Do not use the heater to support any piping.
- 14. A screened straight coupling is provided with the heater for use as an outside exhaust termination.
- 15. A screened inlet air tee is provided with the heater to be used as an outside intake termination.
- 16. Maximum Snow Level Determination: These installation instructions reference snow levels in establishing a minimum height for the installation of exhaust vent or air intake terminations. Snow levels shall be determined as follows:

- a. The installation location may, by ordinance, designate how snow levels are calculated in that location; or
- b. In the absence of specific ordinances, snow levels shall be calculated from the average monthly maximum depth of snow accumulation as indicated by the National Weather Service's 10 year statistics for the installation location/geographical area.

In addition:

- Total length of vent piping shall not exceed the limits specified in this manual.
- The vent piping for this direct vented appliance is approved for zero clearance to combustible construction.
- The flue products coming from the exhaust vent will create a large plume when the heater is in operation. Avoid venting in areas that will affect neighboring buildings or be considered objectionable.
- DO NOT locate exhaust vent or intake pipe in a parking area where machinery may damage the pipe.
- DO NOT vent near soffit vents, crawl space vents, or other areas where condensate or vapor could create a nuisance or hazard or cause property damage.
- DO NOT vent where condensate vapor could cause damage or could be detrimental to the operation of regulators, relief valve, or other equipment.

**In the Commonwealth of Massachusetts and as Required by State and Local Codes:**

- The vented gas fueled appliance shall not be installed so its combustion, ventilation, or dilution air is obtained from a bedroom or bathroom.
- Signage: Whenever any through-the-wall (horizontal or sidewall) vent is installed less than seven feet above the finished grade, a metal or plastic identification plate shall be permanently mounted to the exterior of the building at a minimum height of eight feet above grade directly in line with the exhaust vent terminal. The sign shall read, in print no less than 0.5 inches in size, "GAS VENT DIRECTLY BELOW. KEEP CLEAR OF ALL OBSTRUCTIONS".
- Marking of Exhaust Vent and Intake Pipe: Piping used for ventilation, make-up, or combustion air intake shall be labeled as follows:
  - a. Throughout the entire developed length:
    - i. Labels must be placed every ten feet for exposed/visible piping; or
    - ii. Labels must be placed every three feet for concealed piping.
  - b. At all changes of direction;
  - c. On each side of a penetration through a partition, wall or ceiling; and
  - d. The labels shall be black lettering that:
    - i. Indicates that the piping is used for ventilation, make-up, or combustion air intake, and
    - ii. The letters shall be sized equal to a minimum of the pipe diameter. However, for piping with a diameter exceeding two inches, said lettering does not need to be larger than two inches.

This table lists optional exhaust/intake terminations available from

HTP:

Description	Stock Code
2" PVC Concentric Termination Kit	KGAVT0501CVT
3" PVC Concentric Termination Kit	KGAVT0601CVT
2" Stainless Steel Termination Kit	V500
3" Stainless Steel Termination Kit	V1000
3" Polypro Vent Kit	8400P-001

**Table 16 - Optional Vent Kits**

**H. Applications**

**1. Direct Vent Installation of Exhaust and Intake**

If installing a direct vent option, combustion air must be drawn from the outdoors directly into the water heater intake, and exhaust must terminate outside. There are three basic direct vent options detailed in this manual: 1. Side Wall Venting, 2. Roof Venting, and 3. Unbalanced Venting.

Be sure to locate the heater such that the exhaust vent and intake pipe can be routed through the building and properly terminated. Different vent terminals can be used to simplify and eliminate multiple penetrations in the building structure (see Optional Equipment in Venting Section). The exhaust vent and intake pipe lengths, routing and termination methods must all comply with the methods and limits given in the Venting section of this manual.

When installing a combustion air intake from outdoors, care must be taken to utilize uncontaminated combustion air. **NOTE:** To prevent combustion air contamination, see Table 7.

 <b>WARNING</b>
<p>All vent pipes must be glued, properly supported, and the exhaust pitched a minimum of 1/4" per foot back to the heater to allow drainage of condensate. When placing support brackets on vent piping, the first bracket must be within 1 foot of the water heater and the balance of 4 foot intervals on the vent pipe. Venting must be readily accessible for visual inspection from the first three feet from the heater.</p>
<p>Take extra precaution to adequately support the weight of vent pipes terminating through the roof. Failure to properly support roof terminated piping could result in property damage, serious injury, or death.</p>

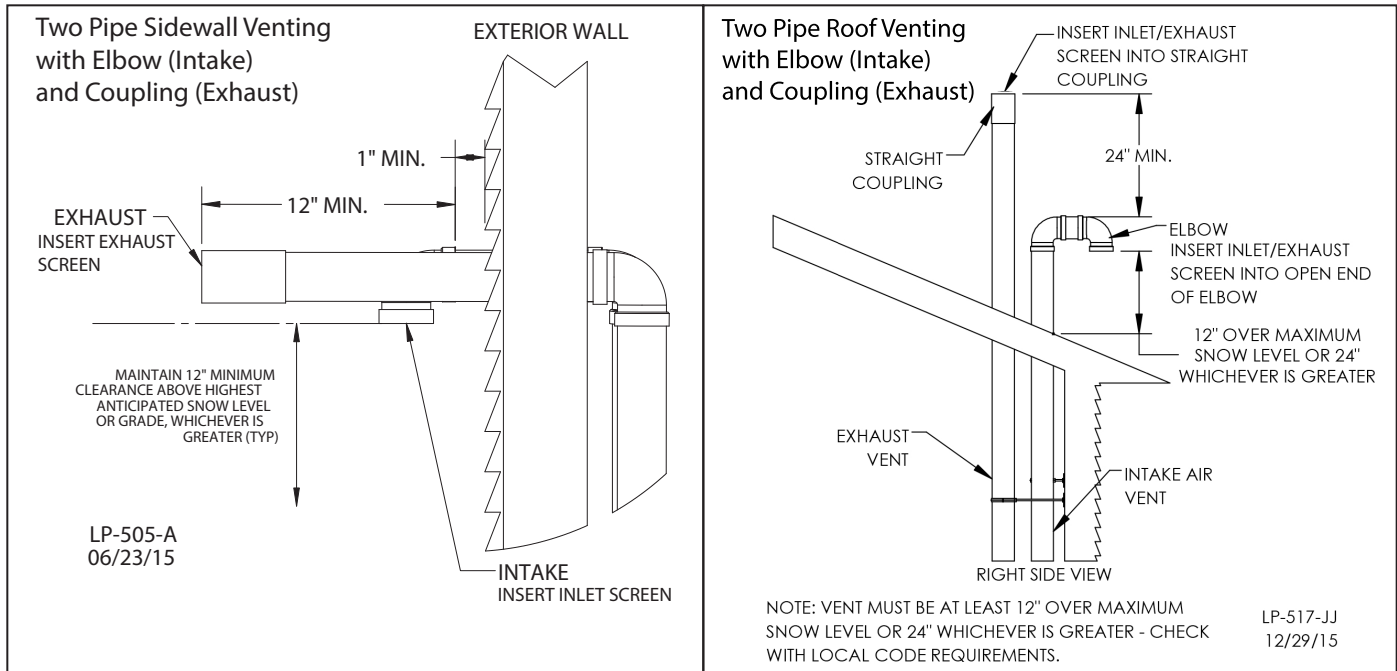

Figure 25 - Direct Vent, Roof and Sidewall Vent Terminations

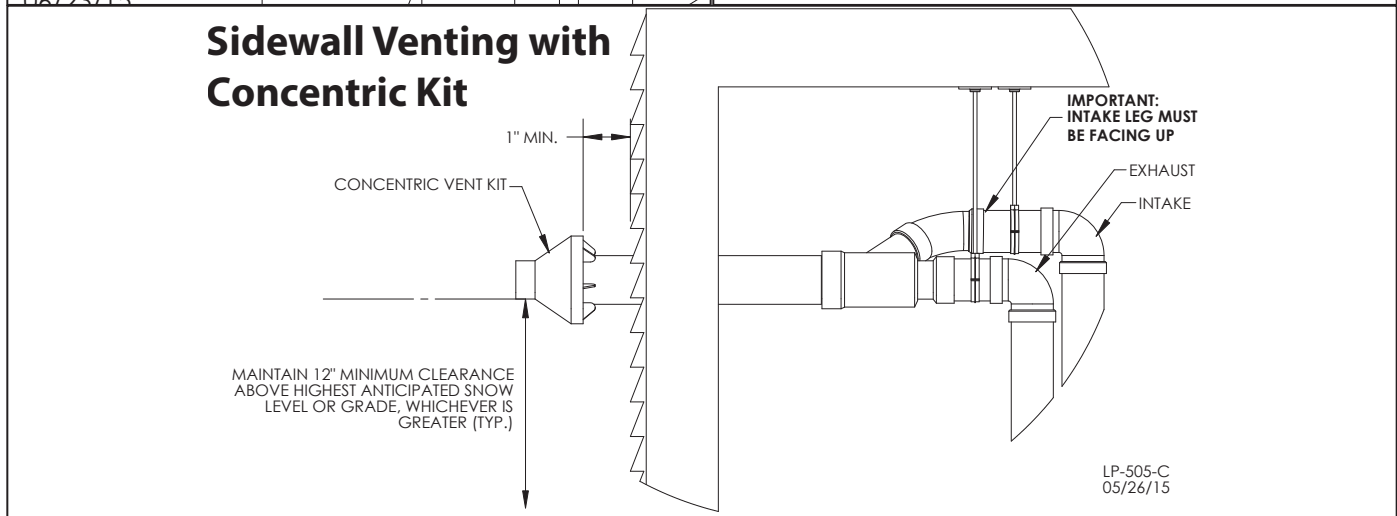
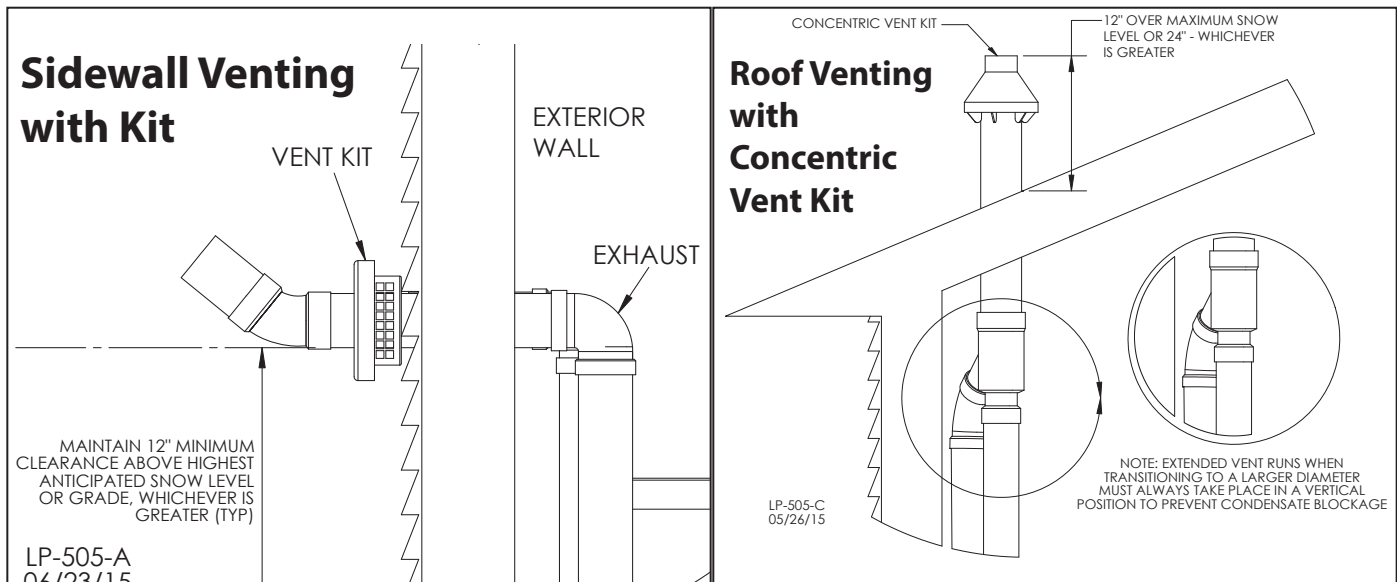
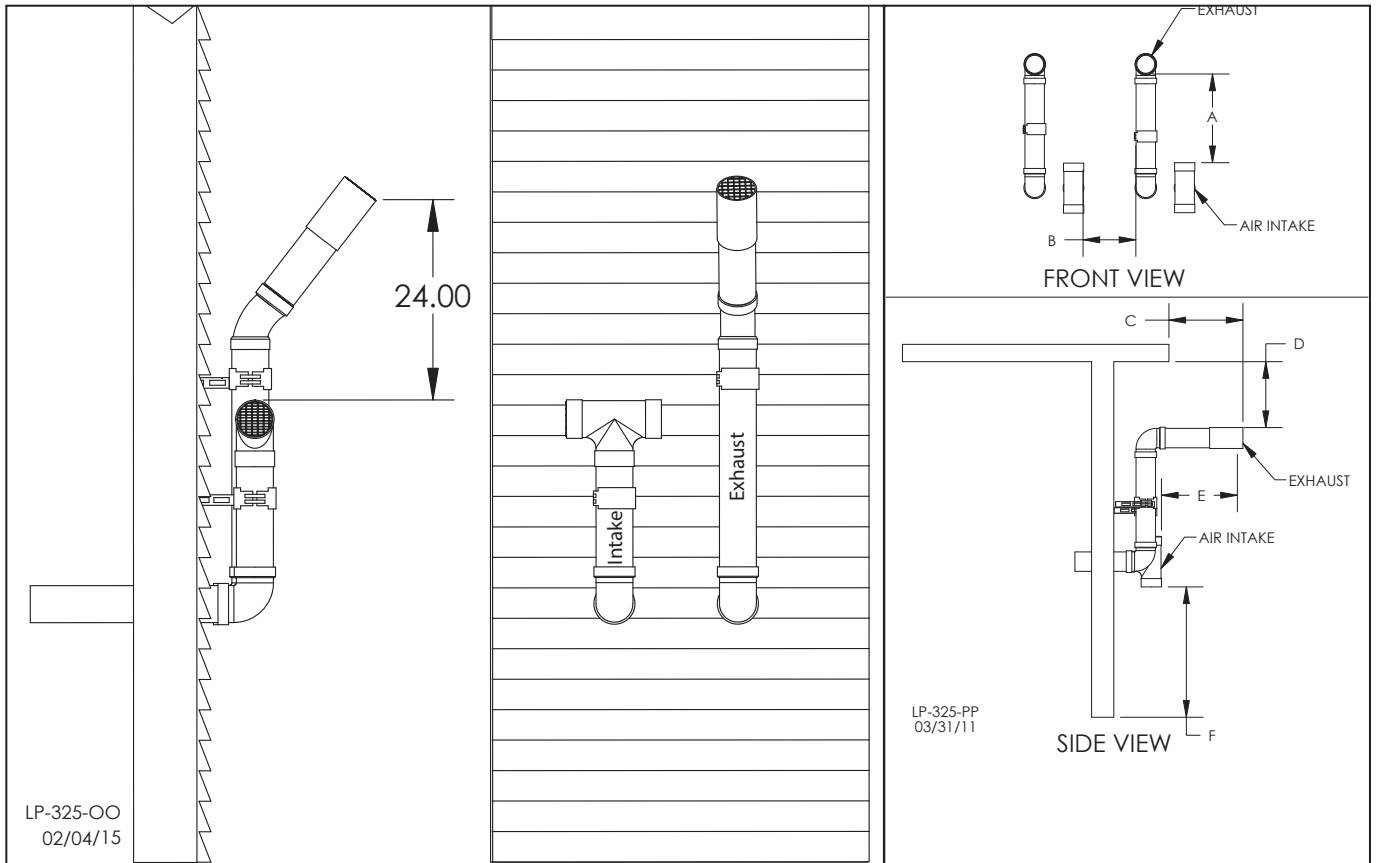

Figure 26 - Direct Vent, Vent Terminations with Optional Kits (NOT INCLUDED WITH THE APPLIANCE)

**NOTE:** These drawings are meant to demonstrate system venting only. The installer is responsible for all equipment and detailing required by local codes.





**Figure 27 - Horizontal (Snorkel) Venting**

**NOTES:**

- A. For every 1" of overhang, the exhaust vent must be located 1" vertical below overhang (overhang means top of building structure and not two adjacent walls [corner of building]).
- B. Typical installations require 12" minimum separation between bottom of exhaust outlet and top of air intake.
- C. Maintain 12" minimum clearance above highest anticipated snow level or grade (whichever is greater).
- D. Minimum 12" between vents when installing multiple vents.
- E. 12" minimum beyond air intake.

**Screen Installation**

After connecting the intake air and exhaust vent pipes, it is required to install the included screens into the exhaust vent and intake pipe terminations to prevent damages to the unit due to blockages. See Figure 28 for installation detail.

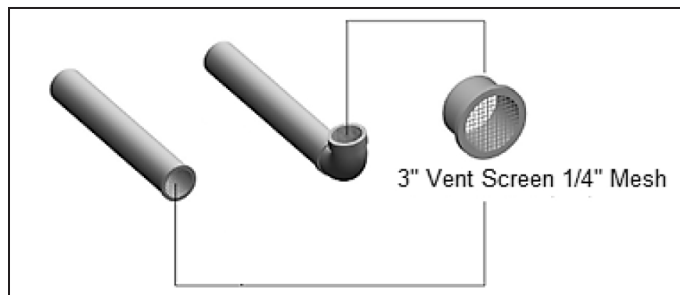

**Figure 28 - Screen Installation - NOTE: Vent termination elbow is meant to be installed open end facing the ground. Orientation in Figure 28 is meant to demonstrate proper Vent Screen installation ONLY.**

**2. Venting Through an Existing System**

This heater may be vented through an existing unused vent system. The inner diameter of the existing vent system is utilized for the combustion air source. Two methods have been approved for such venting: Concentric Venting Through an Existing System and Venting as a Chase.

<b>DANGER</b>
Do not install the heater into a common existing vent with any other appliance. This will cause flue gas spillage or heater malfunction, resulting in substantial property damage, serious personal injury, or death.
<b>CAUTION</b>
Contractors must check state and local codes before installing through an existing vent opening. State and local codes always take precedence over manufacturer's instructions. Failure to check state and local codes before installing through an existing opening could result in property damage and add significantly to installation costs.
If an existing venting system is converted for use with this heater, the installer must ensure that the existing venting system is clean and free from particulate contamination that could damage the heater. Failure to do so could result in property damage and heater failure. Such failure IS NOT covered under warranty.

Concentric venting through an existing system must run vertically through the roof. See Table 17 for proper minimum vent sizing. Use only the approved venting materials specified in Table 12 for piping the system. All instructions listed in this Venting section apply. See Figures 29-1 and 29-2 for venting demonstrations.

Vent / Air Inlet Size	Minimum Existing Vent / Chase Size
2"	4"
3"	5"
4"	7"

**Table 17 - Minimum Existing Vent / Chase Sizing**

<b>DANGER</b>
The upper and lower vent terminations as well as all joints in the venting system must be properly sealed to ensure that all combustion air is drawn properly and exhaust does not leak from the system. Failure to properly seal the venting system will result in property damage, serious personal injury, or death.

**Chase Venting Through an Existing System**

When venting as a chase, follow all instructions included in this Venting section, including those in the previous Concentric Venting Through an Existing System section. See Figure 29-3 for chase venting demonstration.

**Concentric Venting Through an Existing System**

**NOTE:** The following instructions refer only to venting through an existing vent system, and not to venting with HTP's optional concentric vent kits. Refer to Concentric Vent Kit installation manual (LP-166) for further information on venting with the optional concentric vent kits.

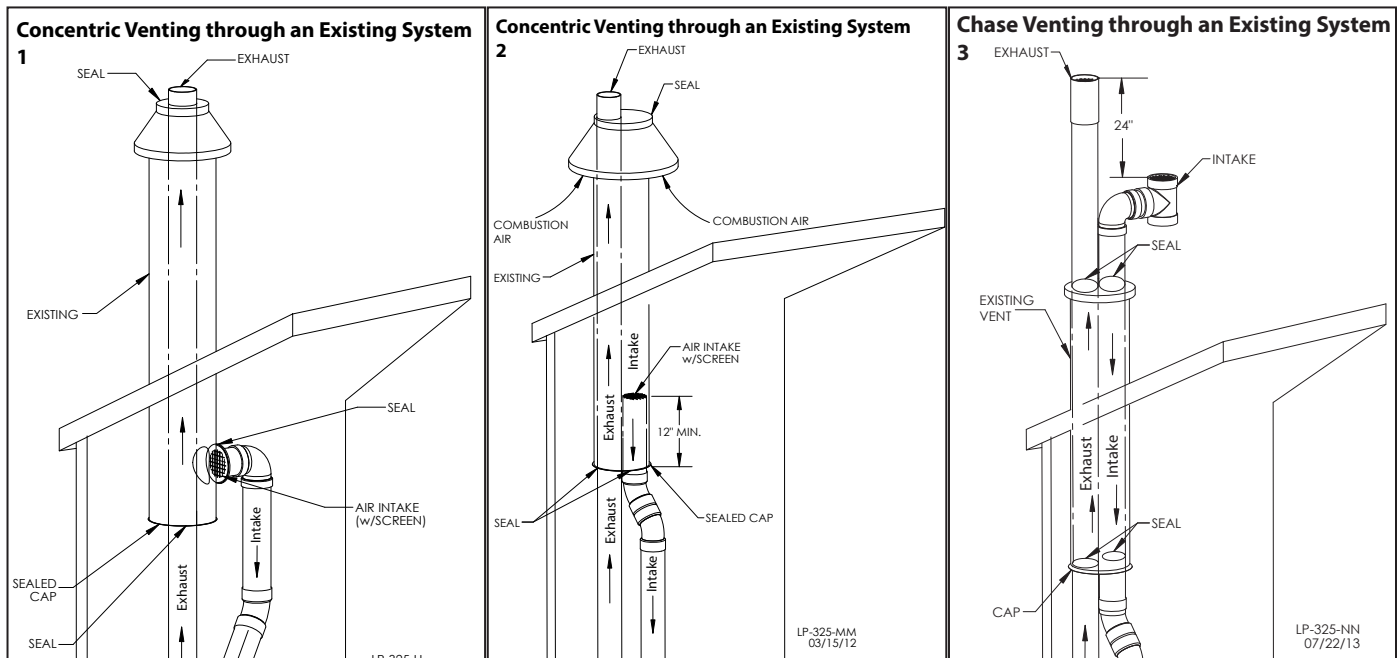

**Figure 29 - 1, 2 - Concentric Venting Through an Existing System, 3, Chase Venting Through an Existing System**

**NOTE:** These drawings are meant to demonstrate system venting only. The installer is responsible for all equipment and detailing required by local codes.

**3. Power Venting, Indoor Combustion Air in Confined or Unconfined Space**

This heater requires fresh, uncontaminated air for safe operation and must be installed in a mechanical room where there is adequate combustion and ventilating air. **NOTE: To prevent combustion air contamination, see Table 7.**

Combustion air from the indoor space can be used if the space has adequate area or when air is provided through a duct or louver to supply sufficient combustion air based on the water heater input.

**Never obstruct the supply of combustion air to the water heater.** If the water heater is installed in areas where indoor air is contaminated (see Figure 30) it is imperative that the water heater be installed as direct vent so that all combustion air is taken directly from the outdoors into the water heater intake connection.

**Unconfined space** is space with volume greater than 50 cubic feet per 1,000 Btu/hour (4.8 cubic meters per kW) of the total input rating of all fuel-burning appliances installed in that space. Rooms connected directly to this space, through openings not furnished with doors, are

considered part of the space.

**Confined space** is space with volume less than 50 cubic feet per 1,000 Btu/hour (4.8 cubic meters per kW) of the total input rating of all fuel-burning appliances installed in that space. Rooms connected directly to this space, through openings not furnished with doors, are considered part of the space.

When drawing combustion air from inside a conventionally constructed building to a confined space, such space should be provided with two permanent openings: one located 6" (15 cm) below the space ceiling, the other 6" (15cm) above the space floor. Each opening should have a free area of one square inch per 1,000 Btu/hr (22cm<sup>2</sup>/kW) of the total input of all appliances in the space, but not less than 100 square inches (645cm<sup>2</sup>).

If the confined space is within a building of tight construction, air for combustion must be obtained from the outdoors as outlined in the Venting section of this manual. See Figure 31.

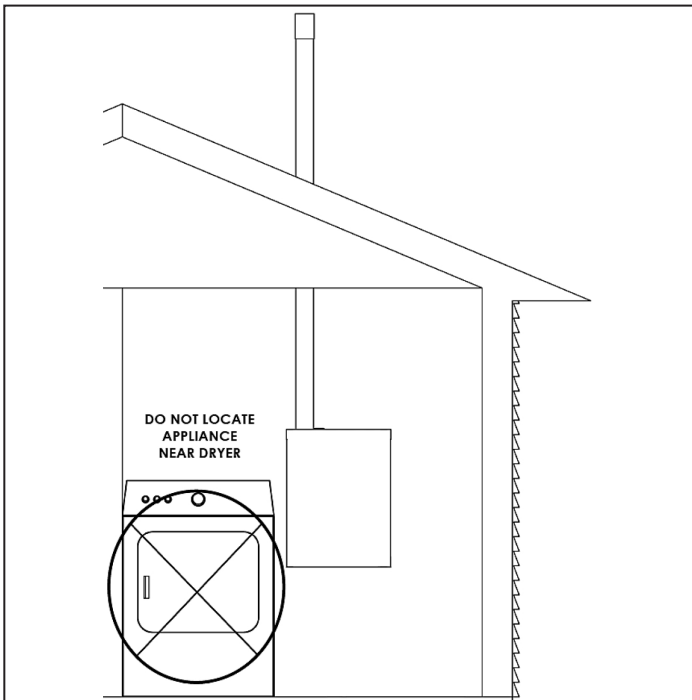

**Figure 30 - Do Not Place Appliance Near Dryer**

**⚠ WARNING**

**Breathing Hazard - Carbon Monoxide Gas**



- Do not operate heater if flood damaged.
- Install vent system in accordance with local codes and manufacturers installation instructions.
- Do not obstruct heater air intake or exhaust. Support all vent piping per manufacturers installation instructions.
- Do not place chemical vapor emitting products near unit.
- According to NFPA 720, carbon monoxide detectors should be installed outside each sleeping area.
- Never operate the heater unless it is vented to the outdoors.
- Analyze the entire vent system to make sure that condensate will not become trapped in a section of vent pipe and therefore reduce the open cross sectional area of the vent.

Breathing carbon monoxide can cause brain damage or death.  
 Always read and understand instruction manual.

LP-304

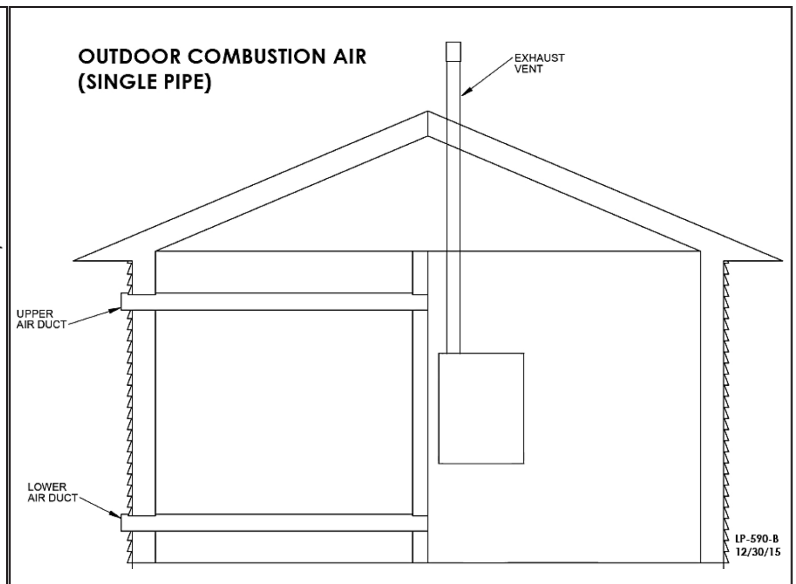
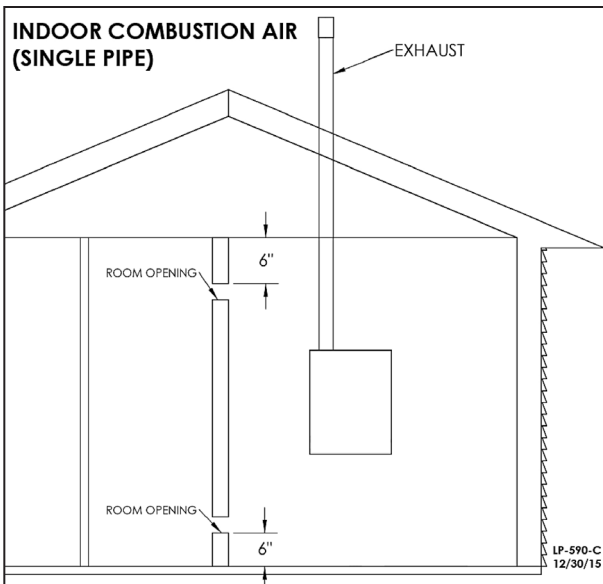

**Figure 31 - Power Venting, Indoor and Outdoor Combustion Air - Single Pipe**

**NOTE:** These drawings are meant to demonstrate system venting only. The installer is responsible for all equipment and detailing required by local codes.

## Part 6 - Installing the Condensate Drain

### CAUTION

This condensing high efficiency water heater has a condensate removal system. Condensate is water vapor derived from combustion products, similar to that produced by an automobile when it is initially started. It is very important that the condensate line is sloped down away from the heater and to a suitable drain. The condensate line must remain unobstructed. If allowed to freeze in the line or obstructed in any other manner, condensate can exit from the water heater tee, resulting in potential water damage to property.

When installing a condensate pump, select one approved for use with condensing heaters and furnaces. The condensate pump should have an overflow switch to prevent property damage from spillage.

Condensate from the heater will be slightly acidic (pH from 3.2 to 4.5). Check with your local gas company to determine if combustion condensate disposal is permitted in your area. Install a neutralizing filter if required by local codes.

### NOTES:

1. Due to its efficient design, the water heater produces condensate (water) as a normal by-product. This condensate is acidic, with a pH level between 3 and 4. This condensate must be drained away from the water heater and disposed in accordance with all local regulations.
2. Condensate line must be pitched at least  $\frac{1}{4}$ " per foot to properly drain. If this cannot be done, or a very long length of condensate hose is used, increase the condensate line to a minimum of 1" ID and place a tee in the line after the condensate neutralizer to properly reduce vacuum lock in the drain line.
3. Use corrosion-resistant materials to drain condensate. Use the included flexible plastic hose or  $\frac{1}{2}$ " PVC and CPVC drain pipe complying with ASTM D1785, F441, or D2665 may be used. Cement must comply with ASTM D2564 for PVC pipe or F493 for CPVC pipe. For Canadian applications, use CSA or ULC certified PVC or CPVC pipe, fittings, and cement.
4. A frozen condensate line could result in a blocked vent condition. It is very important to protect the condensate line from freezing temperatures or any type of blockage. In installations that may

encounter sustained freezing conditions, the use of heat tape is recommended to avoid freezing of the condensate line. It is also recommended to bush up the condensate line size to 1" and terminate condensate discharge as close to the unit as possible. Longer condensate runs are more prone to freezing. Damages due to frozen or blocked condensate lines ARE NOT covered by warranty.

5. Support of the condensate line may be necessary to avoid blockage of the condensate flow.

6. Local building codes may require an in-line neutralizer (1) to be installed (not included) to treat the condensate. If required by local authorities, a condensate

filter of lime crystals, marble, or phosphate chips will neutralize slightly acidic condensate (p/n 7450P-212 available from HTP). Follow all the installation instructions included with the neutralizer. If a neutralizer is installed, periodic replacement of the limestone (or neutralizing agent) will be required. The rate of depletion of the limestone varies with usage of the water heater. During the first year of water heater operation, check the neutralizer every few months for depletion.

7. Route the drain line to a nearby floor drain (2), laundry tub (3), or condensate pump (4). If the heater condensate outlet is lower than the drain, you must use a condensate removal pump (kit p/n 554200 available from HTP).

**NOTE:** If a nearby laundry tub is used as a disposal for waste water from the washing machine, draining the condensate into this tub allows the soapy water discharge to neutralize the acidic condensate.

8. An error will appear on the water heater display if condensate line is blocked. The water heater will not operate with a blocked condensate line. It is extremely important to have this condition repaired by a qualified service technician.

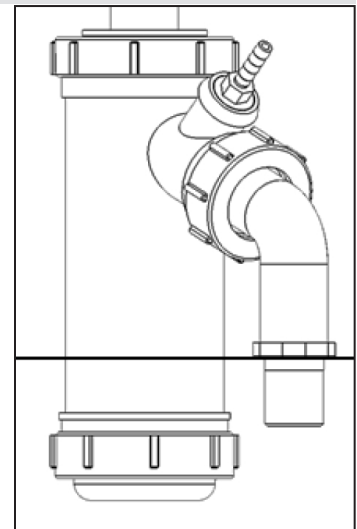

Figure 32 - Internal Condensate Trap

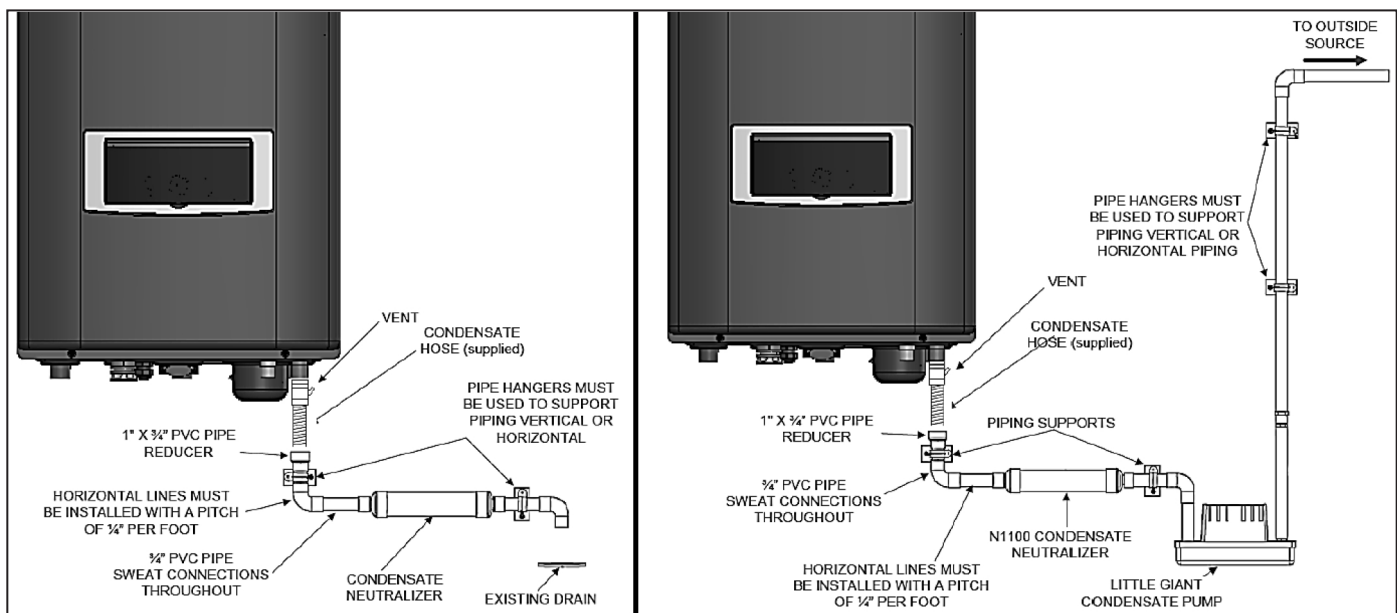

Figure 33 - Internal Condensate Trap

## Part 7 - Connecting Electrical Service

### WARNING

Install wiring and electrically ground water heater in accordance with the authority having jurisdiction or, in the absence of such an authority, follow the National Electrical Code, NFPA 70, and/or CSA C22.1 Electrical Code-Part 1 in Canada. Failure to follow all applicable local, state, and national regulations, mandates, and building supply codes for guidelines to install the electrical power supply could result in property damage, serious personal injury, or death.

**ELECTRICAL SHOCK HAZARD** – To ensure safety, turn off electrical power supply at service entrance panel before making any electrical connections to avoid possible electric shock hazard. Failure to do so could result in property damage, serious personal injury, or death.

Jumping out control circuits or components WILL VOID product warranty and can result in property damage, personal injury, or death.

It is of extreme importance that this unit be properly grounded. It is very important that the building system ground is inspected by a qualified electrician prior to making this connection. Electrical power must only be turned on when the heater is completely filled with cold water. Failure to follow these instructions could result in component or product failure, serious injury, or death.

### CAUTION

Label all wires prior to disconnecting them when servicing the heater. Wiring errors can cause improper and dangerous operation. Failure to follow these instructions may result in property damage or personal injury.

#### A. Wiring

The heater is equipped with a three prong power cord. The heater is limited to a maximum of 8 amps at 120 volts in use.

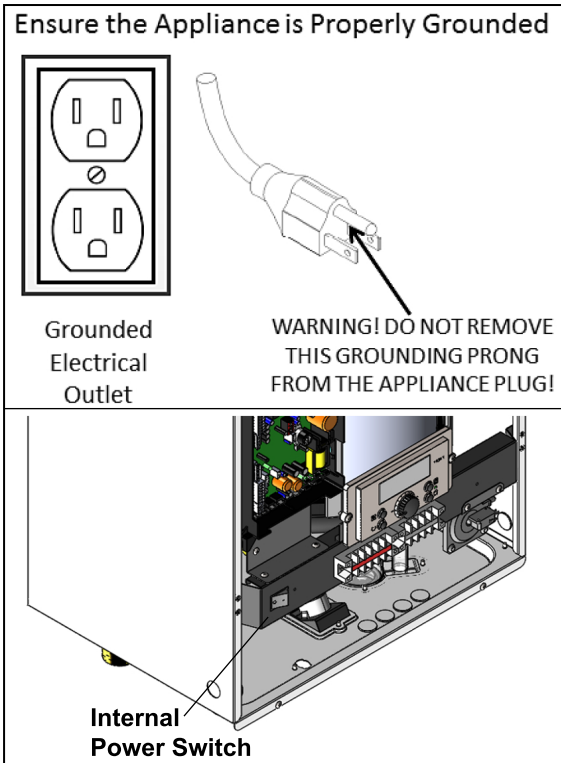

Figure 34 - Proper Grounding - Internal Manual Power Switch

1. This water heater must be properly grounded. Ensure the electrical receptacle is properly grounded. Do not remove the grounding prong from the water heater plug.
2. Do not attach the ground wire to either the gas or water piping.

3. The wiring diagrams in this manual are to be used for reference purposes only.

4. Refer to these diagrams and the wiring diagrams of any external controls used with the installation when wiring the water heater. Read, understand, and follow all wiring instructions supplied with the controls.

5. Do not disconnect the power supply when the water heater is in normal operation.

**NOTE:** For additional electrical protection, the use of a whole house surge protector is recommended. Damage caused by power surges IS NOT covered by the warranty.

### NOTICE

If the water heater display does not turn on, first check the plug. Then check the electrical panel circuit breaker and reset if necessary. If the circuit breaker trips again, do not reset. Disconnect the plug and have a qualified technician diagnose the problem.

#### B. Dip Switches

There is one DIP switch. DIP switches 6 and 7 need to be set to OFF for the water heater to operate normally.

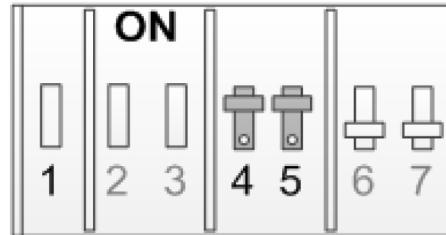

Figure 35 - Proper Grounding - Internal Manual Power Switch

DIP SWITCH		OFF	ON
1-3	Factory	Factory Settings - DO NOT CHANGE	
4	Vent Size	2"	3"
5	Gas Type	LP	NG
6	High Fire	Normal	High Fire
7	Low Fire	Normal	Low Fire

Table 18 - DIP Switch Group - NOTE: DO NOT CHANGE SWITCHES 1-3. THESE ARE FACTORY SETTINGS.

Maximum Flame Detecting Voltage	2.4V
Pre-Purge Time (Tp)	5 seconds
Safety Time (Igniting Time) (Ts)	1 second
Igniting Interval Time	<10 seconds
Post-Purge Time (Tip)	3 minutes
Over-Heating 1, 2, 3, Protection Detection Time	<2 seconds
Temperature Sensor Fault Detection Time	<3 seconds
# of Ignition Attempts (Ntl)	5
DHW Setpoint Temperature Range	100 - 140°F (35 - 60°C)
DHW Off Temperature	DHW Target Temperature + DHW Differential Temperature 9°F (5°C)
DHW On Temperature	Below DHW Target Temperature 9°F (5°C)
DHW Water On Minimum Water Flow	.5 gallons (2 liters) (9Hz)*
DHW Water Off Minimum Water Flow	.4 gallons (1.5 liters) (9Hz)*

Table 19 - System Control Settings - \*NOTE: Zero Activation with Internal Recirculation Mode Active



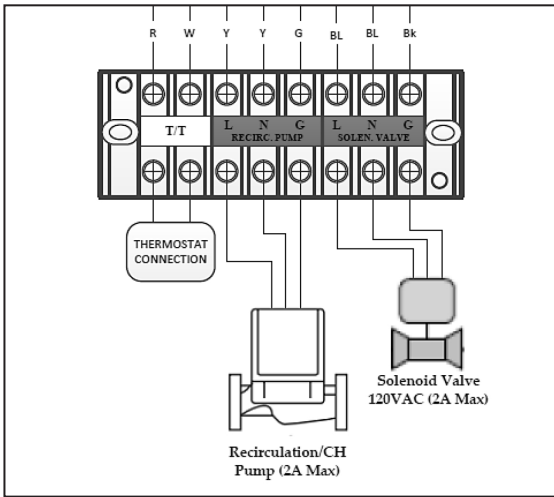

Figure 36 - Wiring Detail

**NOTE:** T/T only operates when Air Handler Application is selected in Installer Menu - 19:SU - AH.

**C. Wiring a Cascaded System**

When wiring the water heater for Cascade operation, select one as the Master water heater. The remaining water heaters will be designated Followers. See "Setting Up a Cascade System" for more details.

Connect the cascade communication cables to every unit. See Figure 37. Add resistor to the end of the last follower.

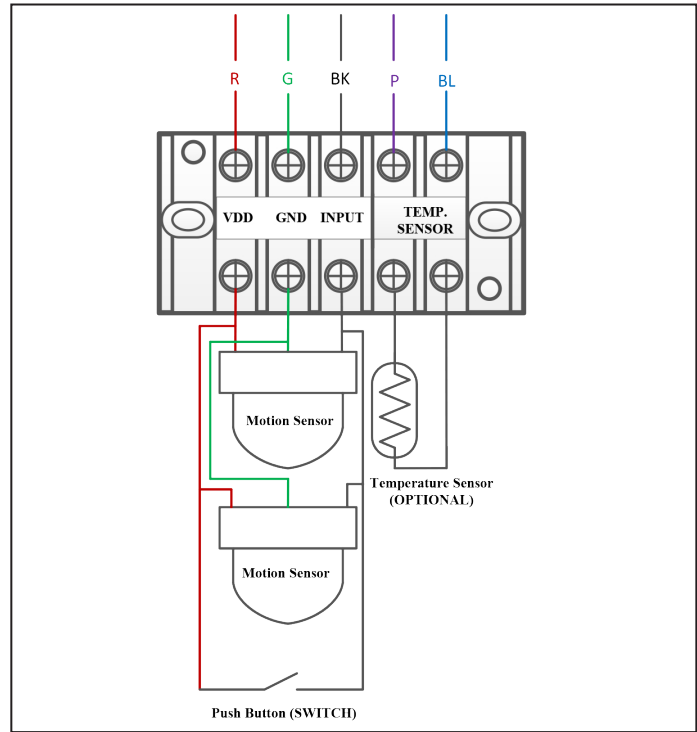

Figure 40 - Title 24 / On Demand Recirculation Wiring Detail

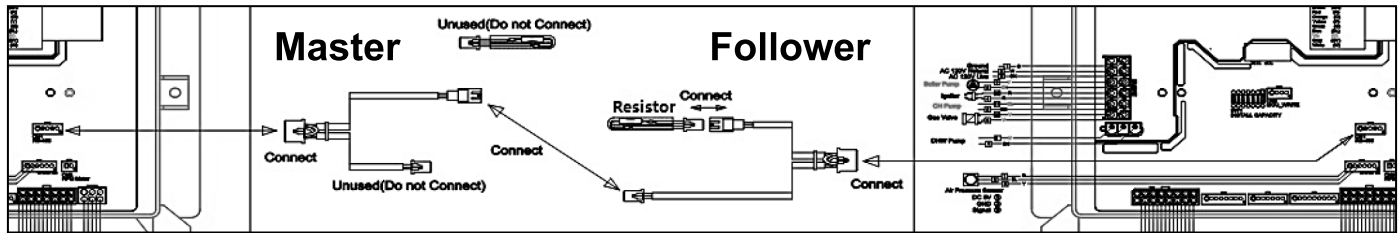

Figure 37 - Cascade Wiring Detail

**NOTE:** The maximum distance between units is two and a half feet. See Figure 41. This maximum distance can be increased by connecting additional wire harnesses together. However, the number of units that can be cascaded will be reduced by one for every additional harness used.

Every cable comes with one resistor. Use only one resistor on the cascaded system. Discard the rest.

**NOTE:** After the cascaded system is set, if you manually turn off the Cascade Master at the display the entire system will shut down.

**NOTE:** After the cascaded system is set, DO NOT turn off a Cascade Follower at the display until you disconnect the cascade cable.

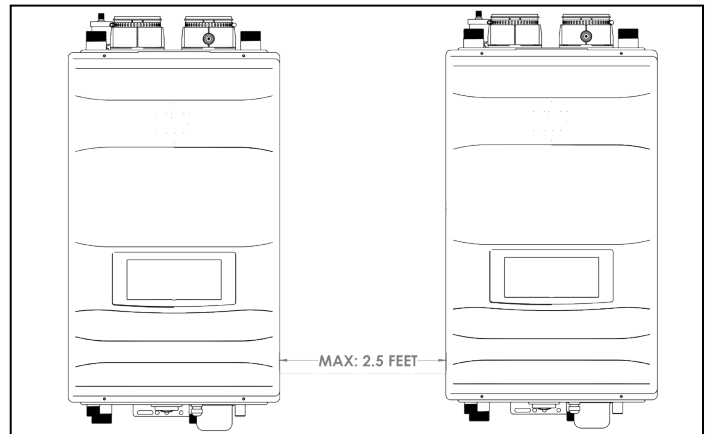

Figure 41 - Maximum Distance Between Wired Cascaded Units

**CAUTION**

When installing a cascaded system, it is important that the water heaters are the same model.

Failure to follow these instructions will result in improper system operation, wasted time, money, and possible property damage and personal injury. Such damages ARE NOT covered by product warranty.

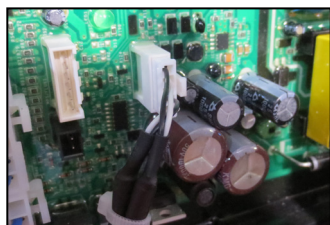

Figure 38 - Cable Wired to Board

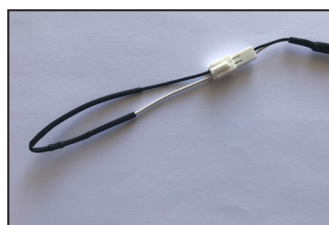

Figure 39 - Installed Resistor

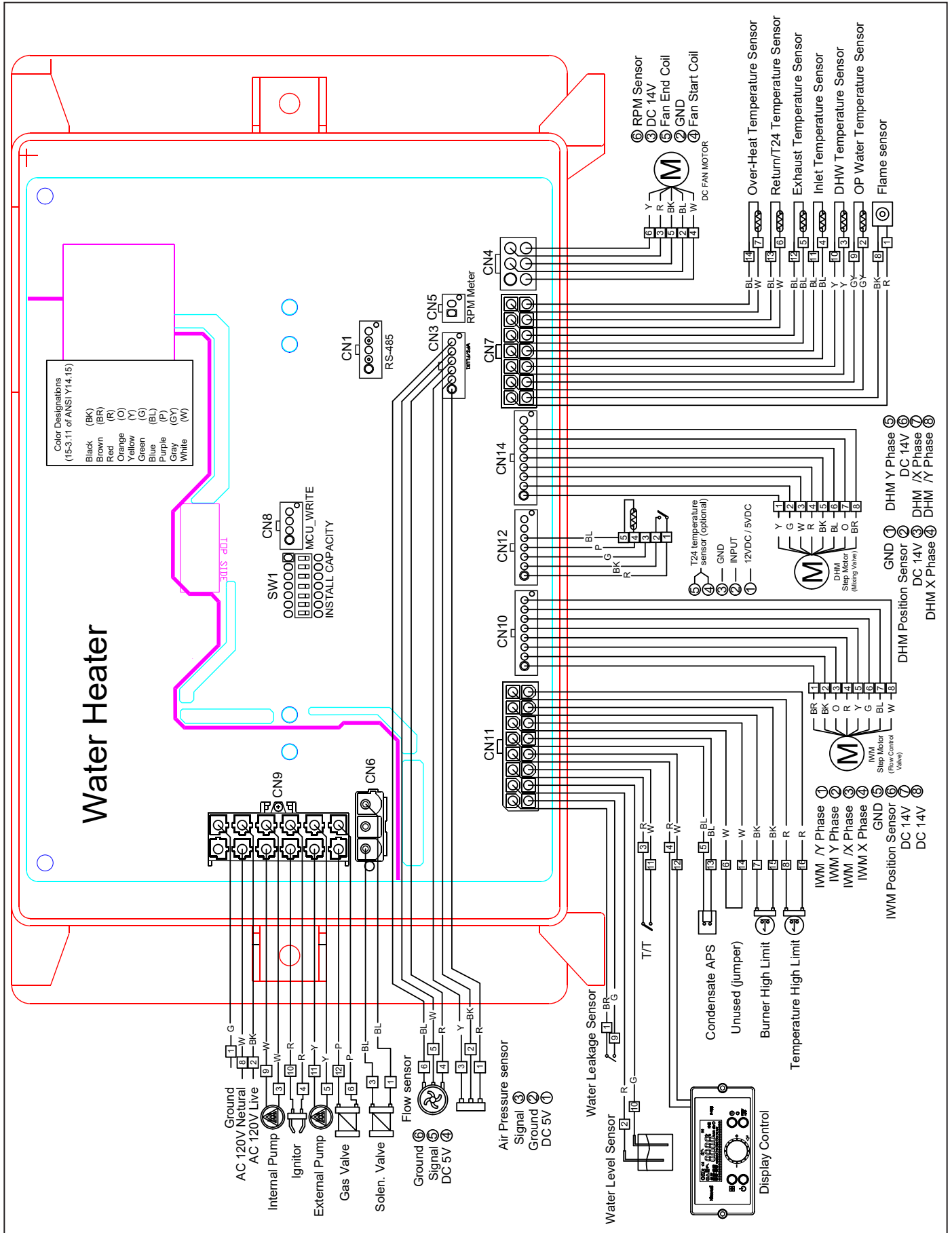

Figure 42 - Electrical Wiring Diagram

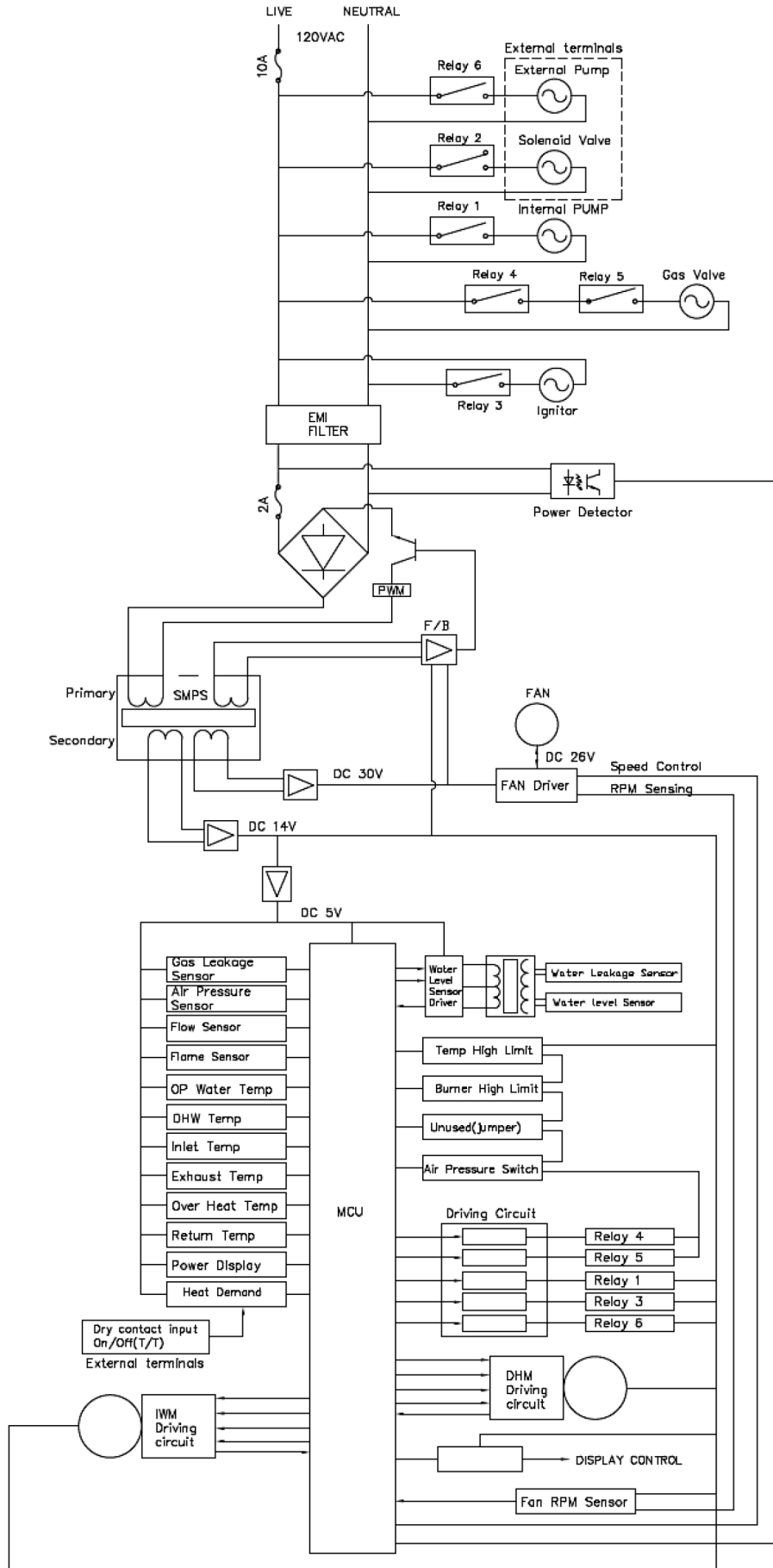

Figure 43 - Ladder Diagram



Connector			Description	HT Selv
No. of Location	Pin	Board Silk		
<b>CN9</b> <b>65001WS-12</b>	1		GROUND	HT (120V~) AC
	2	L	Power Supply Line	
	3	CP1	Heater Pump Power Supply (Live)	
	4	IT	Ignitor Power Supply	
	5	HEAT/CP2	External Pump	
	6	GV	Gas Valve Power Supply	
	7		GROUND	
	8	N	Power Supply (Neutral)	
	9-12		AC Power COM Line	
<b>CN6</b> <b>LW6A4-03</b>	1	CP2/3WAY	Solenoid Valve Power Supply (Live)	
	3		Solenoid Valve Power Supply (Neutral)	
<b>CN1</b> <b>SMW250-05D</b>	1	RS-485	RS-485 +	SELV (5V) DC
	2		RS-485 -	
	3		-	
	4		RS-485 +	
	5		RS-485 -	
<b>CN4</b> <b>LWD1140-06D</b>	1	FAN	NOT USED	-
	2		-	
	3		VDD	SELV (14V) DC
	4		Fan power (start coil)	SELV (8 - 26V) AC
	5		Fan power (end coil)	
	6		Fan speed feedback signal	SELV (14V) DC
<b>CN8</b> <b>LWD1140-16</b>	1	MCU ISP	GND	SELV (5V) DC
	2		ISP / Reset Port	
	3		ISP TOOL0 Data Port	
	4		VCC	
<b>CN11</b> <b>LWD1140-16</b>	1	HWL	Water Leak Detection Sensor	SELV (14V~) AC
	8			
	2	LWL	Water Level Sensor	
	10			
	3	HD	Heat Demand Switch (T/T)	SELV (5V) DC
	11			
	4	TH	Display Control	SELV (14V) DC
	12			
	5	Condensate APS	Condensate Air Pressure Switch	
	13			
	6	Jumper	Jumper	-
	14			
	7	BL	Burner High Limit	SELV (14V) DC
	15			
	8	HL	Water Temperature High Limit	
	16			

Table 20 - Water Heater Wiring 1

Connector			Description	HT SELV
No. of Location	Pin	Board Silk		
<b>CN7</b> <b>LWD1140-14</b>	1	F.S	Flame Sensor	SELV (5V)
	8			
	2	OP.S	Outlet Operating Water Temperature Sensor	
	9			
	3	DH.S	DHW Temperature Sensor	
	10			
	4	I.S	Inlet Water Temperature Sensor	
	11			
	5	BG.S	Exhaust Temperature Sensor	
	12			
	6	ST.S	Return Water Temperature Sensor	
	13			
	7	SP.S	Overheat Temperature Sensor	
	14			
<b>CN10</b> <b>SMW250-08D</b>	1	IWM (Flow Control Valve)	IWM Stepper Motor Coil / Y Phase	SELV (14V)
	2		IWM Stepper Motor Coil / X Phase	
	3		GND	
	4		IWM Stepper Motor Position	
	5		VDD	
	6			
	7			
	8			
<b>CN14</b> <b>SMW250-09D</b>	1	DHM (Mixing Valve)	GND	SELV (14V)
	2		DHM Stepper Motor Position	
	3		VDD	
	4		DHM Stepper Motor Coil X Phase	
	5		DHM Stepper Motor Coil Y Phase	
	6		VDD	
	7		DHM Stepper Motor Coil X Phase	
	8		DHM Stepper Motor Coil Y Phase	
	9		NOT USED	
<b>CN3</b> <b>SMW250-06D</b>	1	APS Sensor	VCC	SELV (5V)
	2		GND	
	3		Voltage Input	
	4	FLUX1	VCC	
	5		Water Flow Sensor	
	6		GND	

Table 21 - Water Heater Wiring 2



## Part 8 - Gas Connections

### WARNING

#### FIRE AND/OR EXPLOSION HAZARD

To avoid serious injury or death, the gas line installation and the gas line inlet pressure test must be done by a licensed professional.

Ensure the gas on which the water heater will operate is the same type specified on the rating plate (natural gas or LP gas). This water heater must be converted into propane operation unless specifically manufactured for use with propane. Follow Gas Conversion Manual instructions (separate document). Propane ready water heaters have the suffix "LP" after the model serial number. Failure to follow these instructions could result in property damage, personal injury, or death.

Make sure the gas line pressures are within normal limits. Pressures outside normal limits can result in poor performance and hazardous operating conditions. Failure to do so could result in property damage, personal injury, or death.

## A. Gas Pipe Sizing Tables

### 1. Gas Pipe Sizing

This information is for reference use only. Refer to gas pipe manufacturer specifications for actual delivery capacity. The DOE standard for Natural Gas is 1100 BTU/ft<sup>3</sup>. Contact the local gas supplier for actual BTU/ft<sup>3</sup> rating.

### 2. Natural Gas Pipe Sizing

The following table lists maximum capacity of pipe in cubic feet of gas per hour for gas pressures of 14" or less and a pressure drop of 0.5 inches water column, based on a 0.60 specific gravity for natural gas.

Pipe Size (in.)	Length of Pipe (Feet)										BTU's Per Hour x 1,000
	10	20	30	40	50	60	80	100	150	200	
3/4	360	247	199	170	151	137	117	104	83	71	Schedule 40 Metallic Pipe  (0.60 Specific Gravity, 0.5 WC Pressure Drop)
1	678	466	374	320	284	257	220	195	157	134	
1 1/4	1390	957	768	657	583	528	452	400	322	275	
1 1/2	2090	1430	1150	985	873	791	677	600	482	412	
2	4020	2760	2220	1900	1680	1520	1300	1160	928	794	
3	11300	7780	6250	5350	4740	4290	3670	3260	2610	2240	
4	23100	15900	12700	10900	9660	8760	7490	6640	5330	4560	

Table 22 - Natural Gas Delivery Capacity - Refer to ANSI Z223.1 - National Fuel Gas Code, Latest Edition

### 3. LP (Liquid Propane) Gas Pipe Sizing

Contact gas supplier to size pipes, tanks, and 100% lockup gas pressure regulator. Adjust propane supply regulator provided by the gas supplier for 14 inches w.c. maximum pressure.

## B. Gas Connection Requirements

- The gas connection fitting on the water heater is 3/4" NPT. **NOTE:** The pipe size must not be less than 3/4".
- The supply line must be sized for the maximum output of the water heater being installed. If there are additional gas appliances from the main supply line, measure the size of the supply line according to the COMBINED total maximum BTUH draw for the appliances as if they were operating at the same time.
- Measure the length of the gas supply line from the gas meter to the water heater. Water heater must be installed downstream of the gas meter to ensure adequate gas supply. Use the tables in this manual or refer to the gas line manufacturer's sizing information to determine the correct supply pipe size.
- The National Fuel Gas Code (NFPA 54) requires that a sediment trap (drip leg) be installed in the gas line on appliances not so equipped. The drip leg must be accessible, a minimum of 3" in length, and not subject to freezing conditions. See Figure 44.
- A manual gas shut-off valve should be installed in the gas supply line close to the water heater. See Figure 44 for detail.
- To facilitate any future maintenance, it is also recommended that an approved gas union fitting be installed in the supply line between the shut-off valve and the 3/4" NPT connection on the water heater.
- Use a manometer to test the gas pressure to make sure it meets the minimum standards and does not exceed the maximum standards of the water heater.
- Leak test the gas line pipe before placing the water heater in operation. Only use approved leak detector liquid solutions to check for leaks.
- Do not operate the water heater until all connections have been completed and the heat exchanger is filled with water.

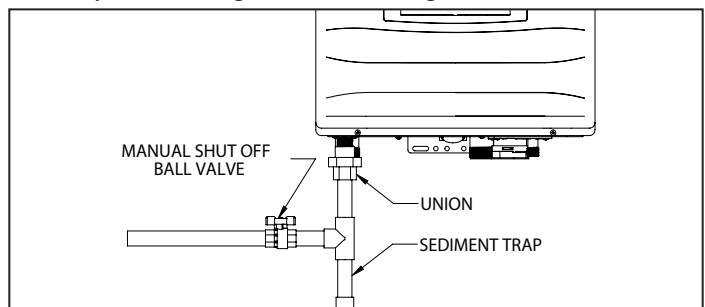

Figure 44 - Gas Line with Shut-Off and Sediment Trap Detail

**C. Additional Precaution for Excess Flow Valve (EFV)**

If an excess flow valve (EFV) is in the gas line, check the manufacturer's minimum and maximum flow capacity ratings. An improperly sized EFV will not allow for a full flow of gas to the water heater and will cause the water heater to malfunction. See Figure 45.

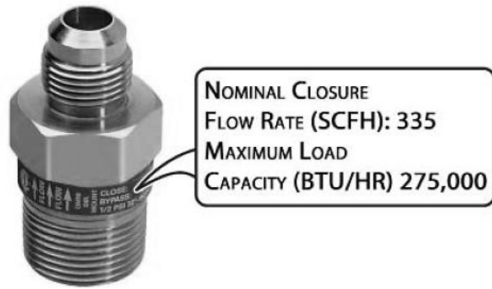

Figure 45 - Excess Flow Valve (EFV)

**D. Checking Gas Pressure at the Water Heater for Proper Operation**

**NOTE:** Refer Figure 46 when checking gas pressure. Loosen the bolts before checking the gas inlet pressure.

1. The water heater and its individual shutoff valve must be disconnected from the gas supply piping system during any pressure testing of the system at test pressures greater than 1/2 psi (3.5 kPa).
  2. The water heater must be isolated from the gas supply piping system by closing its individual manual shutoff valve during any pressure testing of the gas supply piping system at test pressures equal to or less than 1/2 psi (3.5 kPa).
- The minimum and maximum inlet gas line pressures must meet the requirements shown in Table 23.

Natural or LP Gas	
Minimum Pressure	3.5"WC
Maximum Pressure	14"WC

Table 23 - Gas Pressure Requirements

**NOTICE**  
Do not fire (operate) the water heater until all connections have been completed and the heat exchanger is filled with water. Doing so will damage the water heater and void the warranty.

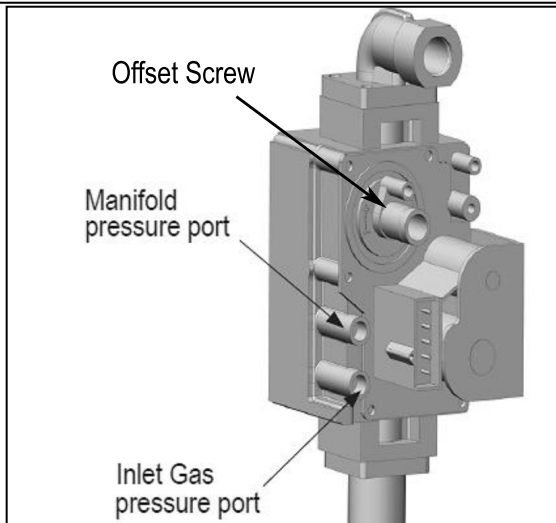

Figure 46 - Gas Valve Detail

**E. Setting and Verifying the Combustion Setting**

1. After the water heater has fired, flip DIP switch seven (7) to the ON position (low fire). Proceed to check heater combustion values.

**NOTE:** Use a combustion analyzer to ensure CO and CO2 values are within the range shown in Table 24.

**WARNING**  
It is required to use a combustion analyzer to verify final adjustment according to the combustion chart (Table 24). Failure to do so could result in serious personal injury or death.

If the readings obtained are lower or higher than the combustion readings in Table 24, use a T15 Torx screwdriver to adjust the offset screw in a clockwise (positive) or counterclockwise (negative) direction (approximately 1/4 turn). See Figure 46. Check your combustion values. Repeat this procedure until the values obtained on the combustion analyzer agree with those stated in Table 24.

**NOTE:** If the heater makes a whistling sound (harmonics) at low fire, adjust the offset screw in a clockwise (positive) direction (approximately 1/8 turn). Check your combustion values and ensure they agree with those stated in Table 24 before proceeding.

2. When low fire settings have been obtained, flip DIP switch seven (7) to its original (OFF) position. This will return the heater to normal operation.
  3. Flip DIP switch six (6) to ON (high fire). Again check combustion readings with a combustion analyzer.
- NOTE:** DO NOT adjust the gas valve offset screw at high fire. The offset screw is only used to adjust combustion values at low fire.
4. When complete, flip DIP switch six (6) to its original (OFF) position. This will return the heater to normal operation.
  5. Allow heater to operate normally. Ensure it is operating properly.
  6. Reinstall the heater front cover.
  7. Use a Phillips Head screwdriver to reinstall the heater top cover.

**WARNING**  
It is very important that the combustion system be set within the recommended CO measurements listed in Table 24. Visually looking at the burner does not determine combustion quality. Failure to measure combustion with a Combustion Analyzer and set the throttle within the recommended CO measurements could result in property damage, severe personal injury, or death.

Fan Speed	Natural Gas		LP Gas	
	Low	High	Low	High
CO PPM	≤175		≤175	
CO <sub>2</sub> (%)	8 - 9 1/2	8 1/2 - 10	9 - 10 1/2	9 1/2 - 11

Table 24 - Combustion Settings

**WARNING**  
**Breathing Hazard - Carbon Monoxide Gas**

- Do not operate heater if flood damaged.
- Install vent system in accordance with local codes and manufacturers installation instructions.
- Do not obstruct heater air intake or exhaust. Support all vent piping per manufacturers installation instructions.
- Do not place chemical vapor emitting products near unit.
- According to NFPA 720, carbon monoxide detectors should be installed outside each sleeping area.
- Never operate the heater unless it is vented to the outdoors.
- Analyze the entire vent system to make sure that condensate will not become trapped in a section of vent pipe and therefore reduce the open cross sectional area of the vent.

**Breathing carbon monoxide can cause brain damage or death. Always read and understand instruction manual.**

## Part 9 - Controls

### A. Control and Display Overviews

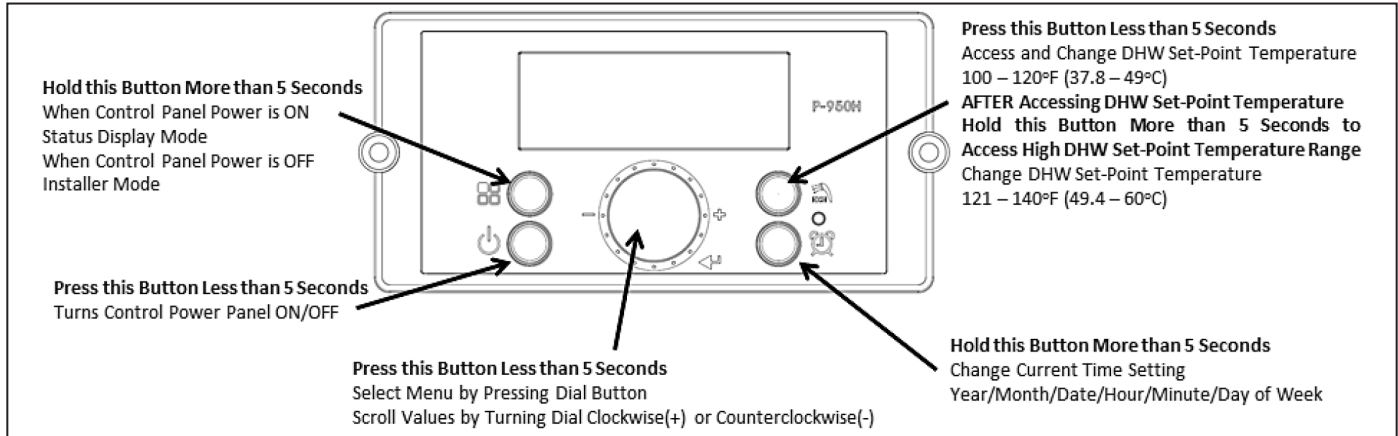

Figure 47 - Control Panel Detail

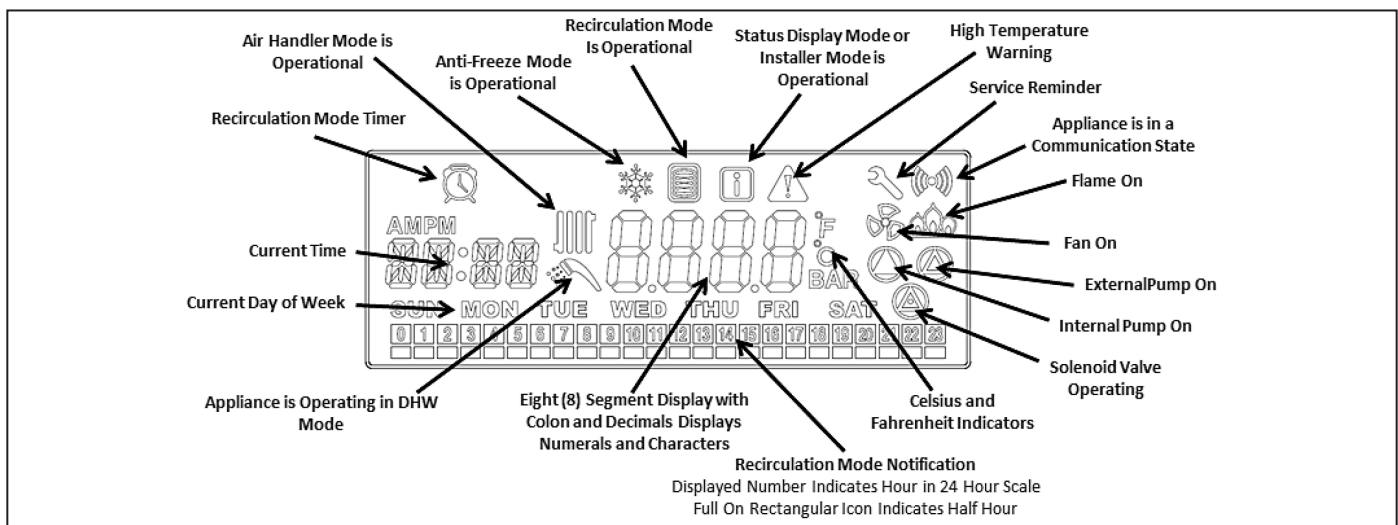

Figure 48 - LCD Display

LCD also features a backlit lamp that will illuminate:

- When a user action is detected (a button is pressed)
- The display has timed out for approximately 2 minutes

After start-up, the display appears as follows.

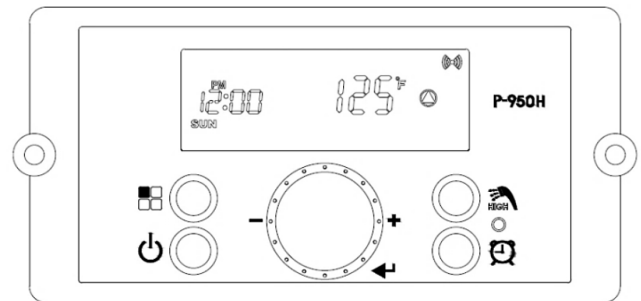



Figure 49 - Initial Display Screen

The Control System can operate through user and service modes that have specific LCD outputs and dedicated controls, including:

- Changing the DHW Set-Point Temperature
- Changing Time
- Status Display
- Installer Mode
- Error Mode
- High Elevation Mode
- Lock Function

**NOTE:** The Control System will not allow changes if Lock Mode is activated. Press and hold the  button for five seconds to unlock the control.

### B. Start-Up Sequence

After the appliance is powered ON, the LCD display shows a sequence of information. The icons will flash, followed by various indicators that describe the appliance controller and software versions. It will take the appliance roughly 15 seconds to cycle through the Start-Up Sequence.

Display Items	Time for Display	Remarks
LCD Test	1 sec	All segments "ON"
	0.5 sec	All segments "OFF"
Category RGH-150 / 199	1 sec	Pdn
	1 sec	0061
Software Version for Front Panel	1 sec	SPn
	1 sec	00.xx
Software Version for Water Heater	1 sec	SFn
	1 sec	xx.xx
Hardware Version for Water Heater	1 sec	Hdn
	1 sec	00xx

Table 25 - Start-Up Sequence

### C. Changing the DHW Set-Point

**NOTE:** The setpoint cannot be changed if water is flowing through the unit. Ensure there is no demand on the water heater when changing the setpoint.

The display shows the  icon when the DHW set-point can be changed.

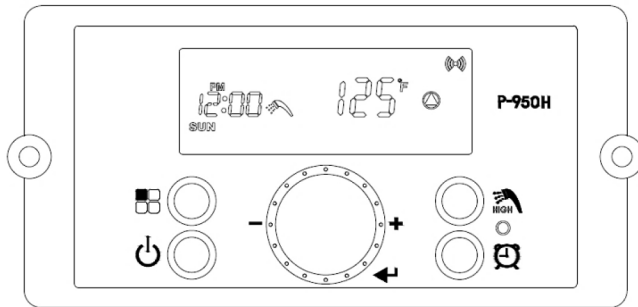











Figure 50 - DHW Set-Point Screen

Press the  button when the display panel is powered ON to change the DHW Set-Point. The DHW icon and current set-point will display and flash. This indicates that the DHW Set-Point can be changed. Factory DHW Set-Point is 125°F (51°C). Initial DHW Set-Point range is 100 – 120°F (38 – 49°C).

Turn the dial  counterclockwise to lower and clockwise to raise the DHW set-point. After changing the temperature, press the  button to save the set-point.

To change the DHW Set-Point above 121°F (49.5°C) press, then press and hold the  button when the display panel is powered ON. The DHW icon and current set-point will display and flash. Then press and hold the  button for five seconds. The scald warning symbol “” (high temperature) will display. High temperature DHW Set-Point range is 121 – 140°F (49.5 – 60°C).

To change the DHW Set-Point above 140°F (60°C), go into the Installer Mode. Advance to parameter 21:rE and change the setting from rE to Co. Then leave Installer Mode. Press the  button. The current DHW set-point will display. The temperature range is now 95 – 160°F (35 – 71.1°C).

Turn the dial  counterclockwise to lower and clockwise to raise the DHW set-point. After changing the temperature, press the  button to save the set-point.

## DANGER

Hotter water increases the risk of scald injury. Scalding may occur within 5 seconds at a setting of 140°F (60°C). Water temperature over 125°F can instantly cause severe burns, or death, from scalds. Children, disabled, and elderly are at the highest risk of being scalded. See instruction manual before setting temperature at appliance. Feel water before bathing or showering!

**NOTE:** After a DHW demand has been met, the pump will run for a set period of time to normalize heat exchanger temperature and prevent scale build-up.

### D. Changing the Time

Press and hold the  button for five seconds when the display panel is powered ON to change the time. The settings can be adjusted as follows: Year / Month / Date / Hour / Minute / Day of Week.

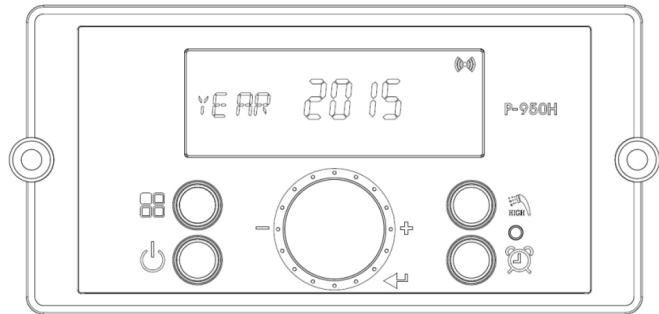







Figure 51 - Changing the Time Screen

Turn the dial  counterclockwise to lower and clockwise to raise the current time setting. After changing the setting, press the  button to save it. The next adjustable setting will appear. After the time and date have been set, press the  button to save and return to the main screen.

### E. Lock Function

To turn on Lock Function, press the  button at the P:Lc parameter when scrolling through the Status Display screens. Turn the dial  counterclockwise to lower and clockwise to turn Lock Function On or Off. Press the  button to return to normal operation.





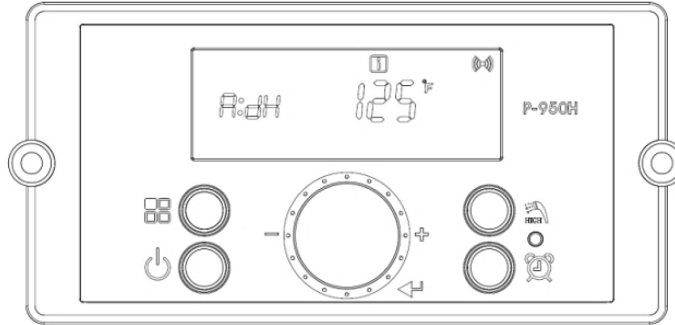

**NOTE:** The control system will not allow changes if Lock Function is activated. Lock Function will have to be turned off before making further changes.

**F. Status Display**





Status Display will activate when button  is pressed and held for five seconds at Standby Mode.



**Figure 52 - Status Display Screen**

Display (Main Menu)	Display (Sub Menu)	Detail		Description
	<b>A:GA or A:LI</b>	Flow Unit		Current Flow Unit (LI: Liters/min, GA: Gallons/min)
	<b>b:dH</b>	DHW outlet water temperature		Current DHW target temperature
	<b>C:In</b>	DHW inlet water temperature		Current DHW inlet water temperature
	<b>d:Rt</b>	Recirculation return water temperature		Current recirculation return water temperature
	<b>E:oP</b>	Heat exchanger outlet water temperature		Current heat exchanger outlet water temperature
	<b>F:Eh</b>	Exhaust temperature		Current exhaust temperature
	<b>H:oH</b>	Overheat water temperature (HX)		Current overheat water temperature (HX)
	<b>I:Fr</b>	Fan Speed (RPM)		Current Fan Speed (RPM)
<b>L:rt</b>	<b>1:PH</b>	Burner Operation Time	Power supply	Time water heater has been powered in 1000 hour units
	<b>2:rh</b>		Burner operating time	Time burner has operated in 1 hour units
	<b>3:rH</b>		Burner operating time	Time burner has operated in 1000 hour units
	<b>4:It</b>		Ignition attempts	Number of ignition attempts: 10 times the displayed unit
	<b>5:IH</b>		Ignition attempts	Number of ignition attempts: 10,000 times the displayed unit
<b>M:CC</b>	<b>SELF</b>	Capacity of Master (percentage)		N/A
	<b>ALL</b>	Total Cascade Capacity (percentage)		N/A
	<b>F1 - F19</b>	Capacity of individual water heaters (percentage)		N/A
<b>The following recirculation settings can be adjusted. See Using Recirculation Modes, Steps 1 and 2, this section, for further details.</b>				
<b>N:St</b>	<b>Auto</b>	-	Default Recirculation Function	
	<b>Pro1</b>	<b>4-9:30 AM, 4-7:30 PM</b>	Recirculation Program 1 (preprogrammed or adjustable)	
	<b>Pro2</b>	<b>6-7:30 AM, 6-7:30 PM</b>	Recirculation Program 2 (preprogrammed or adjustable)	
	<b>Pro3</b>	-	Recirculation Program 3 (completely customized program)	
	<b>PULS</b>	<b>10</b>	Recirculation Pulse Function	
			See Table 29 for more information. <b>NOTE:</b> Before setting the Recirculation Function, go into the Installer Mode and change 0:RC from  or  to  (Internal Recirculation Mode) or  (External Recirculation Mode). Recirculation Mode will not work if it is not activated. <b>NOTE:</b> If  or  are selected, these settings cannot be changed.	
<b>O:tt</b>	<b>00</b>	Optional Recirculation Temperature		Current recirculation temperature (using external pipe sensor) when using Title 24 Mode. 00 will display when sensor is not connected.
<b>P:Lc</b>	<b>OFF</b>	Lock Function		Turns Lock Function On and Off

**Table 26 - Status Display Screen Descriptions**

Turn the dial  counterclockwise and clockwise to scroll through the displayed parameters. To view parameter details, press the  button at the appropriate screen. Press the  or  buttons to leave the parameter. Press the  button again to return to Operation Mode.



## G. Installer Mode

Installer Mode will activate when button  is pressed and held for five seconds while the water heater display is powered Off.

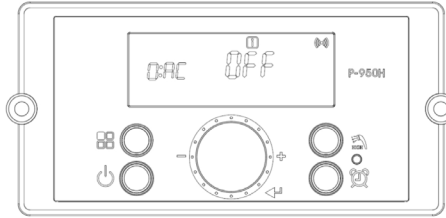





Figure 53 - Installer Mode Screens

Display	Default	Detail	Description
0:RC	OFF	Recirculation Pump Operation	OFF : Recirculation Pump is not used. (Recirculation and Preheat Modes are OFF)
			EE24 : Title 24 Mode (Required in California, Optional in other states). Recirculation Mode requires a switch or motion sensor to activate.
			P-HE : Preheat Mode is used. The water heater automatically turns on and meets the DHW setpoint temperature when the internal temperature falls below the differential setting (15:So).
			IN-RC : Internal Recirculation Mode - Internal Recirculation Pump is used.
			EX-RC : External Recirculation Mode - External Recirculation Pump is used.
1:EH	E0.00	Error history up to 10	Check ten most recent Error Codes (E0 - E9)
2:cE	OFF	Clear Error History	Select "ON" to Clear Error History. Range: ON or OFF
3:In	OFF	System Reset (Factory Setting)	Select "ON" to restore system to default factory settings (Burner operation time, Ignition cycles, and Supply power time will not be reset.) Range: ON or OFF
4:FH	00	Maximum Fan Speed	Adjusts maximum fan speed. Range: -30 to +30
5:FL	00	Minimum Fan Speed	Adjusts minimum fan speed. Range: -30 to +30
6:dr	NO	Reset Burner Operation Time	Select "YES" to Reset Burner Operation Time Range: YES or NO
7:dl	NO	Reset Ignition Cycle	Select "YES" to Reset Ignition Cycles Range: YES or NO
8:Cn	0	Cascade Address	Cascade Address Range: 0 (Master), 1 (follower 1), ..., 20 (follower 19). Default: 0. <b>NOTE:</b> "9:cP" needs to be set with total number of units in the cascade parameter before setting "8: cn" <b>NOTE:</b> The Master water heater must always be addressed 0.
9:CP	1	Cascade Parameter	Number of Units Cascaded Range: 01 - 20
10:CI	01	Minimum Operating Number for Cascade Units	Selects how many cascaded units will operate simultaneously when a DHW demand is initially received. Range: From 1 to Total Number of Units Cascaded
11:Eh	OFF	Factory Setting	Factory Setting - DO NOT CHANGE
12:Cr	Auto	Auto	Automatic Rotation (default) The first unit to operate when there is a DHW call is the unit that ran the least amount of time during the prior heat calls (burner ON time).
	Cr:Ct	48	Cascade Rotation Time <b>NOTE:</b> If unit is set to run continuously, this parameter must be set, NOT Automatic Rotation (Cr:at) to ensure even unit run time. Range: 0 - 240 Hours
13:HA	0-2	High Elevation Mode	This water heater may be installed at elevations up to 10,000 feet and operate on either Natural or LP. The appliance will de-rate by 4% for each 1000 feet above sea level. Select the appropriate installation location as described below. Selects Installation Location for Proper Water Heater Operation at Altitude: 0-2 for installation locations from sea level to 1999 feet 2-5 for locations from 2000 to 4999 feet 5-8 for locations from 5000 to 7999 feet, 8-10 for locations from 8000 to 10000 feet Default: 0 - 2 <b>NOTE:</b> Use a combustion analyzer to ensure CO and CO2 are within the ranges shown in this manual. Adjust the offset screw in the clockwise (positive) or counterclockwise (negative) directions (approximately 1/8 turn) if the measured CO2 value on LOW FIRE is out of range.

14:AP	AP:cP	5	Pump Test Mode	This function sets the time to run pumps and powers the solenoid valve to purge air from the system. Range: 1 - 30 Minutes
	Pu:oF or Pu:on	OFF		Turn this function ON to activate pump testing. Only works in installation mode. Turns off when in normal mode.
15:SS	SS:Sd	OFF	OFF	Sets the date of the next service reminder: XX/XX/XXXX (Month/Day/Year)
		YEAR	Service Reminder Date	
		MON		
	DATE			
SS:br	0	Service Reminder Run Hours	Sets the next service reminder based on burner run hours. (OFF, 0 - 9000 hours)	
16:So		15 F	Preheat, Recirculation, and/or Air Handler Differential Temperature	When set, the water heater will turn on when water temperature falls below this differential temperature setting. Example: If set point is 125°F and differential is 10°F, the water heater will turn on when water temperature falls below 115°F. <b>NOTE:</b> This parameter is operational on Recirculation and Air Handler Modes ONLY. Default: 15°F. Range: 9 - 36°F.
17:UC	FAH (F)	FAH (F)	Temperature Measurement Unit	Allows the user to change the temperature measurement unit from Fahrenheit to Celsius.
	CEL (C)			
18:IM	ON	ON	IWM Step Motor Mode	IWM Step Motor is in use (ON) or not in use (OFF).
	OFF			
19:dt		0	Delay time from DHW Mode to Recirculation or Air Handler Modes	Range: 0 - 2 minutes
20:SU		Cd	Solenoid Valve Operation	Cd – Comfort Mode. When this mode is active the solenoid valve energizes when the water heater is over 90% of the capacity, and deactivate when water heater is less than 50% of the capacity. This can be used in combination with a combi appliance to increase the domestic hot water production of the system. AH – Air Handler Mode – This mode must be active when using an Air Handler application. The pump will operate for 60 seconds every 6 hours if there was not a call for heat to sanitize recirculation water. Range: Cd – AH, Default: Cd <b>NOTE:</b> If AH is not selected when using an air handler T/T will not operate.
21:rE	rE	rE	Select rE or Co	Changes DHW Setpoint Temperature Range rE (95 - 140°F [35 - 60°C]) or Co (95 - 160°F [35 - 71.1°C])
	Co			

**Table 27 - Installer Mode Descriptions**

Turn the dial  counterclockwise and clockwise to scroll through the displayed parameters. To view parameter details, press the  button at the appropriate screen. Turn the dial  counterclockwise and clockwise to change the selected parameter. To save the setting press the  button.

To leave Installer Mode, press the  button again. The display will return to power off mode.

## H. Setting Up a Cascaded System

### CAUTION

A maximum of sixteen (16) models may be installed in a cascaded system. Installing more than the maximum amount of water heaters in a cascaded system will result in system problems, property damage, and premature water heater failure. Such problems ARE NOT covered by product warranty.

### WARNING

For each floor containing bedroom(s), a carbon monoxide detector and alarm shall be placed in the living area outside the bedrooms, as well as in the mechanical room that houses the heater. Detectors and alarms shall comply with NFPA 720 (latest edition). Failure to comply with these requirements could result in product damage, severe personal injury, or death.

**Program the Master and Follower Water Heaters in a Cascade System:**

To program the cascade system, first enter the Installer Mode. Scroll down to and select the following parameters on each water heater in the system:

1. 9:cP – Set the number of units in the cascade loop [range from 1-20].
2. 8:cn – Next, set the cascade address (Master should always be addressed 0) [range from 0-19]. 15:cn cannot be changed until 16:cP is set.

**NOTE:** The cascade Master must be addressed 0. Followers may be given any address from 1 - 19, but addresses should NEVER be repeated.

**NOTE:** To service any follower unit, turn main power switch off to that unit.

**Program the Master Water Heater Setpoint:**

To finish programming the cascade system, enter the Installer Mode on the Master ONLY.

1. Set the DHW setpoint on the Master. This DHW setpoint will be the same on all of the Followers.
2. Set the Water Heater Recirculation Function (if used).

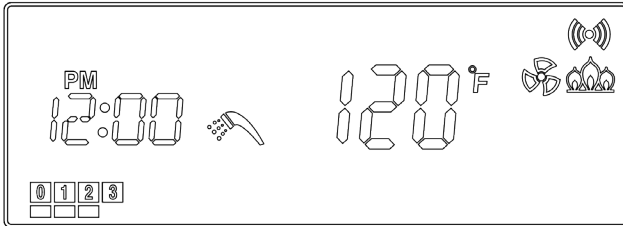

This is the Cascade Master display screen. It is operating.

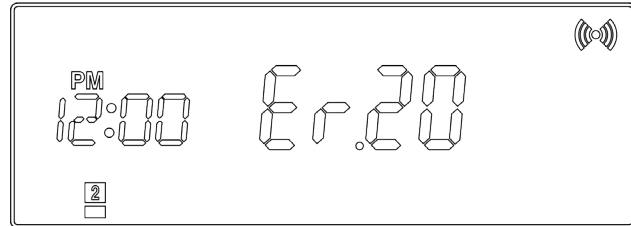

This is the Cascade Follower 1 display screen. It is operating.

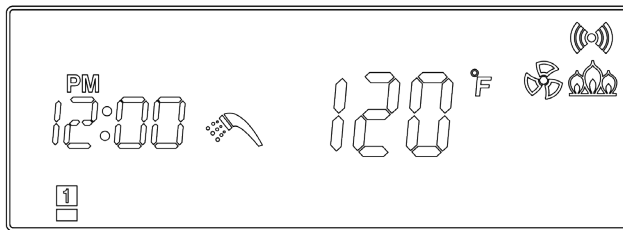

This is the Cascade Follower 2 display screen. It shows an Error Code.

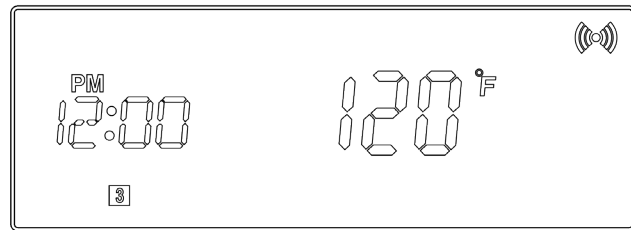

This is the Cascade Follower 3 display screen. It is in standby mode.

**Figure 55 - Cascade Display Screen Examples**

**I. Using Recirculation Modes - Step 1**

The following section explains and details the use of the Internal / External Recirculation Modes.

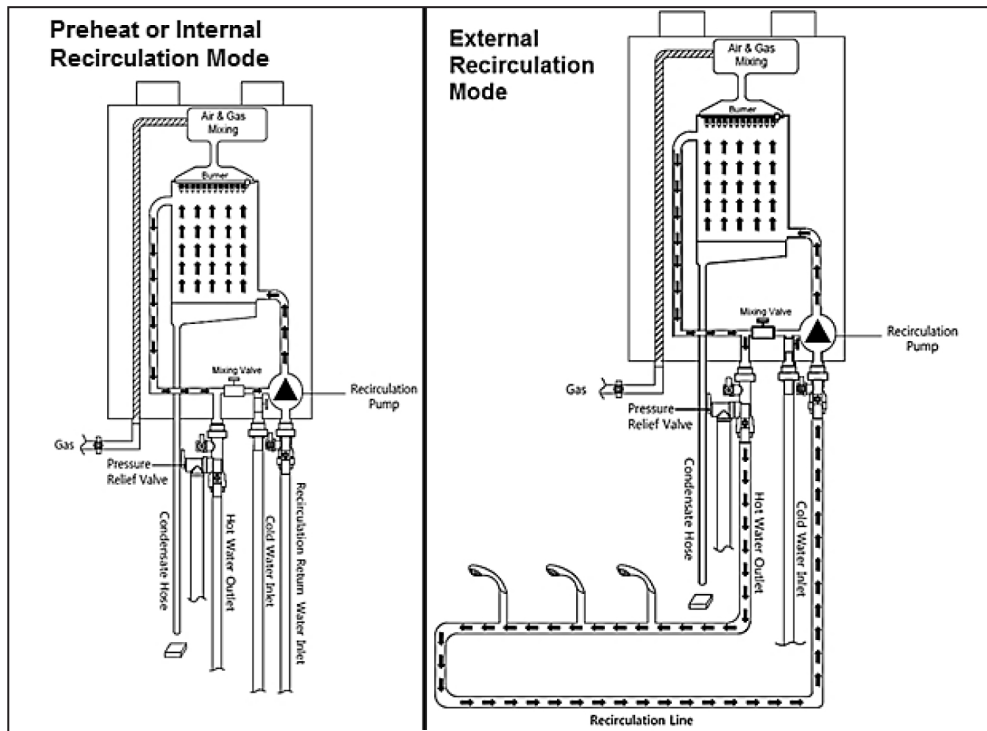

**Figure 54 - Recirculation Modes**

**Preheat or Internal Recirculation Modes** – When calls for hot water are satisfied, the water heater is factory programmed to Preheat and automatically maintain the temperature set point of the water heater – 24 hours a day, 7 days a week. The differential setting can be adjusted to control the temperature set point.

Internal Recirculation Mode allows the installer to program specific recirculation functions by day and time to circulate and heat water more efficiently - when the user most needs hot water. See Recirculation Functions, this manual, for details.

**External Recirculation Mode** – This mode keeps an external recirculation loop warm to make hot water production more efficient and also aid in freeze protection. An external recirculation line must be installed in order to recirculate water externally. The installer may program specific recirculation functions by day and time to circulate and heat water when the user most needs hot water. See Recirculation Functions, this manual, for details.

To set Recirculation Modes:

1. Installer Mode will activate when **BB** is pressed and held for five seconds while the water heater display is powered Off.
2. Turn the dial to O:RC. Press the Dial button **<P>**. "OFF" will flash when the O:RC setting is ready to be changed.
3. Turn the dial to select "OFF" to shut off Recirculation Mode, "T24" to use Title 24 Mode, "InRC" to use Internal Recirculation, "EARC" to use External Recirculation, or "PreHt" to turn on Preheat Mode. Press the dial button **<P>** to select the setting and return to the Installer Mode.

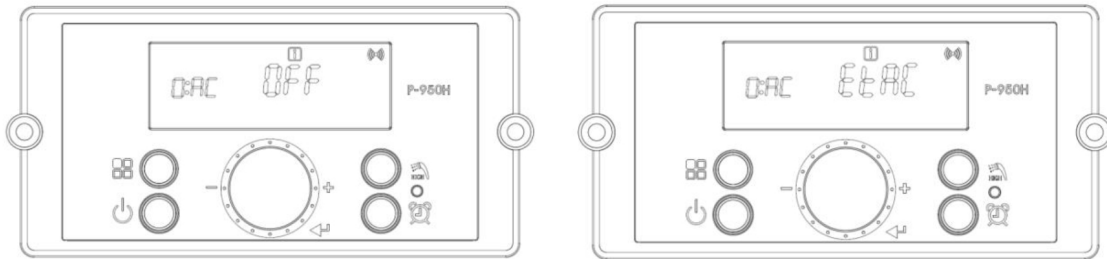

Figure 56 - Internal / External Recirculation Mode Screens

Setting	Detail	Description
OFF (Factory Default)	Recirculation Mode Off	Turns off Recirculation Pumps and Preheat Mode
T24	Title 24 Mode	Turns on Title 24 Mode
PreHt	Preheat Mode	Turns on Preheat Mode
InRC	Internal Recirculation Mode	Turns on Internal Recirculation
EARC	External Recirculation Mode	Turns on External Recirculation

Table 28 - Internal / External Recirculation Mode Overview

4. When finished, press **BB** to exit this menu and turn power back on. Proceed to Step 2 to program recirculation functions.

**NOTE:** It is recommended to have Preheat Mode on for faster hot water delivery.

**NOTE:** The Recirculation Functions below do not refer to the "OFF" or "PreHt" settings. In the PreHt setting, the water heater automatically turns on and meets the DHW setpoint temperature when the internal temperature falls below the differential setting (15: So).

**J. Recirculation Functions - Using Recirculation Modes - Step 2**

NOTICE

Before setting the Recirculation Function, go into the Installer Mode and change O: RC from OFF to T24 (Title 24 Mode), InRC (Internal Recirculation Mode), or EARC (External Recirculation Mode). Recirculation Mode will not work if it is not activated in Installer Mode. See Tables 28 and 29 for details.

**Title 24 Mode**

**NOTE:** An optional On Demand Recirculation kit is required to use Title 24 Mode. A push button switch or motion sensor is required to activate recirculation, and an external pipe sensor may be used to monitor recirculation loop temperature.

Install the optional Title 24 Mode kit according to the included instructions. Then turn on the water heater. Enter Installer Mode, O:RC, and choose T24, Title 24 Mode. Then enter Status Display Mode, O:tt, and set the system recirculation temperature.

**Internal and External Recirculation Modes**

The following section details the InRC (Internal Recirculation Mode) and EARC (External Recirculation Mode) Recirculation Functions.

**NOTE:** When External Recirculation Mode is active and there is no hot water demand, DHW temperature is limited to 125°F (51°C). This is intended to decrease the risk of scalding. The water heater will heat water to temperatures greater than 125°F (51°C) if the DHW set-point is higher than 125°F (51°C) and there is a demand for hot water.

**NOTE:** The optional On Demand Recirculation kit can be used to activate recirculation when unit is set to Internal or External Recirculation Modes.

**! DANGER**

Hotter water increases the risk of scald injury. Scalding may occur within 5 seconds at a setting of 140°F (60°C). Water temperature over 125°F can instantly cause severe burns, or death, from scalds. Children, disabled, and elderly are at the highest risk of being scalded. See instruction manual before setting temperature at appliance. Feel water before bathing or showering!

**NOTE:** In all Recirculation Functions but Pulse: When Recirculation is operational and the burner turns off, the pump will continue to run for seven (7) minutes and stop for three (3) minutes. This cycle will repeat until the burner turns on or the recirculation timer ends.

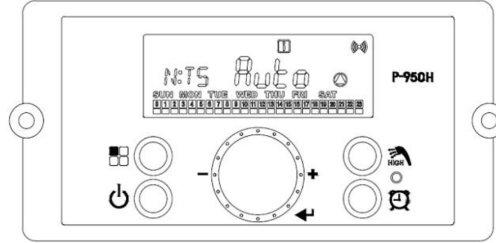





Figure 57 - Recirculation Programming Screens

Setting	Detail	Description
<b>Auto</b>	Smart Auto-Learn (Default Internal / External Recirculation Mode Function)	When set in Smart Auto-Learn, the pump will run in the Pulse Function for the first seven (7) days. During this period the water heater will monitor and record hot water usage patterns. After the initial seven (7) day learning period, the water heater will use the preceding week's usage pattern to cycle the pump and preheat the water.
<b>Pro1</b>	Recirculation Program 1	Pro1 is a factory set recirculation setting with day and time values. This setting can be customized for your installation. Day and Time can be programmed. Default: 4 - 9:30 AM, 4 - 7:30 PM
<b>Pro2</b>	Recirculation Program 2	Pro2 is a factory set recirculation setting with day and time values. This setting can be customized for your installation. Day and Time can be programmed. Default: 6 - 7:30AM, 6 - 7:30 PM
<b>Pro3</b>	Recirculation Program 3	Pro3 is a recirculation setting that can be completely customized for your installation. Day and Time can be programmed. There is no default setting.
<b>PULS</b>	Pulse	In Pulse, the pump runs for a set time every hour to internally or externally maintain hot water temperature on selected days. The burner will turn on during this period if the heat exchanger water temperature drops below the Recirculation Differential Temperature (15:So). Range: 1 – 60 minutes, Default: 10 minutes.

Table 29 - Recirculation Function Overview

**1. Smart Auto-Learn Recirculation Function**

- a. Enter Status Display by pressing and holding button  for five seconds at Standby Mode.
- b. Turn the dial button to the N:TS screen. Press the  button to open the Recirculation Functions.
- c. Press the  button at the "Auto" screen to select the Smart Auto-Learn Recirculation Function. See Figure 58.
- d. The water heater is now in Smart Auto-Learn Recirculation Function.

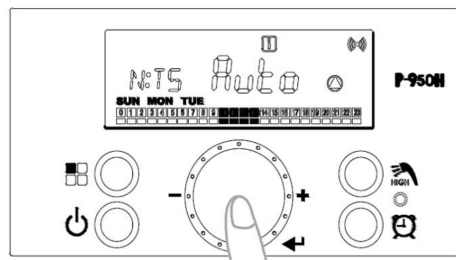





Figure 58 - Set Auto-Learn Recirculation Function

**2. Pro1, Pro2, Pro3, and PULS Recirculation Function**

- a. Enter Status Display by pressing and holding button  for five seconds at Standby Mode.
- b. Turn the dial button to the N:TS screen. Press the  button to open the Recirculation Functions.
- c. Turn the dial button at the "Pro1", "Pro2", "Pro3", or "PULS" screens to select a Recirculation Function. See Figure 59 A. Press the  button to select the mode.
- d. Press the  button to enter the day setting. See Figure 59 B.



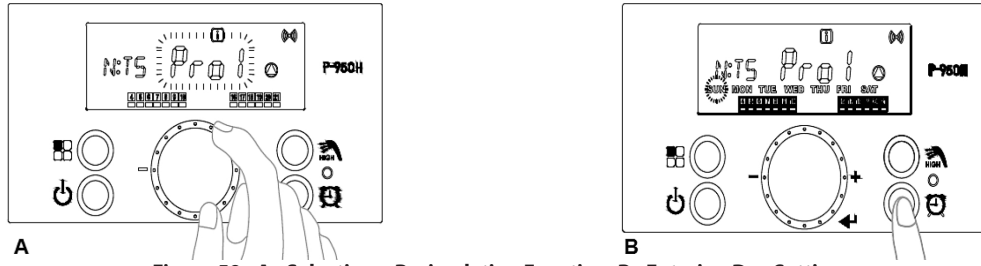

Figure 59 - A - Selecting a Recirculation Function, B - Entering Day Setting

e. The default day is displayed when the program function is selected. Press the button to remove a day. Turn the dial to select other days. See Figure 60 A.

f. Press the button to set the time. See Figure 60 B.



Figure 60 - A - Selecting the Day, Turning the Dial to Other Days, B - Setting the Time

i. Turn the dial button to set the time. See Figure 61 A. Wait for the time to flash twice.

j. Press the button to store the time setting. See Figure 61 B.

**NOTE:** If a mistake is made when setting the date or time, it can be cleared or restored to the default time. Press the key to select Clr (to clear the date and time) dEF (to restore the date and time to the factory default). Press the button to clear or restore. Or go to the Installer Menu, 3: In, to reset the unit to factory settings and start over.



Figure 61 - A - Setting the Time, B - Storing the Time Setting

k. Press the button to store the time setting. Press the button again to leave Recirculation Function.

l. The water heater is now ready to operate in the selected Recirculation Function.

## Part 10 - Troubleshooting

### A. Error Code

When the water heater encounters an error, the display will flash "Er" followed by a numerical code. The water heater shall enter a soft lockout condition if the error is such that it can return to normal operation once the condition relieves itself (overheat conditions, NTC open or shorts, etc.). The water heater shall enter a hard lockout if the condition indicates something more serious (flame, ignition, condensate line, etc.) To clear a hard lockout Error Code, press the Power button. See Figure 62 B.

The following screen will display when the water heater encounters an error.

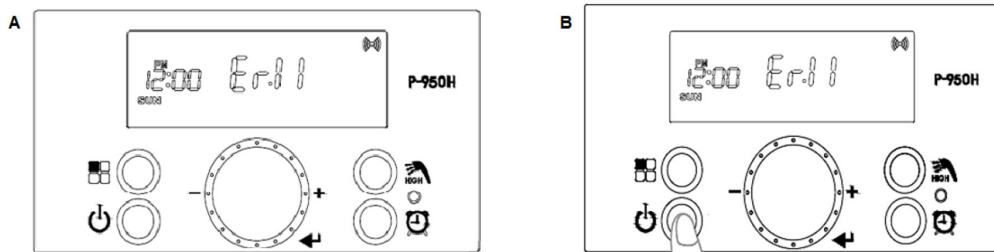

Figure 62 - A - Error Screen, B - Resetting an Error Code

Error Code	Error Code Description	Possible Remedies
<b>Er:10</b>	Flame has extinguished 5 (five) times	<p>Press the Power button to clear the Error Code. The Code will also automatically reset after one hour (up to three (3) times).</p> <p>If Error happens again:</p> <ol style="list-style-type: none"> <li>1. Monitor the gas pressure to the water heater while in operation. Ensure pressure is between 3.5 and 14" WC.</li> <li>2. Check gas valve wire. Ensure connection is secure.</li> <li>3. Check flame detection sensor. Ensure connections are secure. Normal operating settings are more than 2.5DC before ignition, less than 2.5DC after ignition.</li> <li>4. Check vent terminations. Ensure there are no blockages.</li> <li>5. Assure that the flame is stable when lit.</li> <li>6. If the problem persists, replace the main control.</li> </ol>
<b>Er:11</b>	Ignition has failed 5 (five) times	<p>Press the Power button to clear the Error Code. The Code will also automatically reset after one hour (up to three (3) times).</p> <p>If Error happens again:</p> <ol style="list-style-type: none"> <li>1. Monitor the gas pressure to the water heater while in operation. Ensure pressure is between 3.5 and 14" WC.</li> <li>2. Check gas valve wire. Ensure connection is secure.</li> <li>3. Check flame detection sensor. Ensure connections are secure. Normal operating settings are more than 2.5DC before ignition, less than 2.5DC after ignition.</li> <li>4. Check igniter transformer for proper connection.</li> <li>5. Clean the spark igniter with steel wool to remove oxides. Ensure proper separation (3-4 mm).</li> <li>6. Replace the spark igniter if damaged.</li> <li>7. Assure that the flame is stable when lit.</li> <li>8. If the problem persists, replace the main control.</li> </ol>
<b>Er:16</b>	Operating Temperature (OP) Sensor Detects Water Temperature Greater than 199°F (93°C)	<p>This Error Code will go away when the DHW temperature decreases.</p> <p>If Error happens again:</p> <ol style="list-style-type: none"> <li>1. Check if dip switch High Fire setting is ON. Switches 6 and 7 should be OFF for normal operation.</li> <li>2. Check if DHW inlet pipe is blocked. Ensure there is enough water flowing to the water heater.</li> <li>3. Check DHW sensor at DHW outlet. If resistance is zero, replace the sensor.</li> <li>4. Check Operating Temperature sensor at the heat exchanger. If resistance is zero, replace the sensor.</li> <li>5. If the problem persists, replace the main control.</li> </ol>
<b>Er:20</b>	Temperature High Limit Overheat Switch - Closed is Normal, Open is Fault	<p>Press the Power button to clear the Error Code.</p> <ol style="list-style-type: none"> <li>1. Inspect the High Limit Overheat switch. Ensure proper connections.</li> <li>2. Check High Limit Overheat switch resistance. If resistance is not zero, replace the switch.</li> <li>3. If the problem persists, replace the main control.</li> </ol>
<b>Er:28</b>	Overheat (OH) Sensor Open or Short	<p>This Error Code will go away when temperature decreases.</p> <p>If Error happens again:</p> <ol style="list-style-type: none"> <li>1. Check overheat temperature sensor. Ensure connections are secure.</li> <li>2. Check overheat sensor resistance. If resistance is zero, replace the sensor.</li> <li>3. If the problem persists, replace the main control.</li> </ol>
<b>Er:29</b>	APS/Condensate - Closed is Normal, Open is Fault (Condensate Drain Trap)	<p>Press the Power button to clear the Error Code.</p> <ol style="list-style-type: none"> <li>1. Check APS/Condensate and main controller connections. Ensure all are secure.</li> <li>2. Check APS/Condensate resistance. If resistance is not zero, replace the switch.</li> <li>3. Check APS/Condensate hose. Ensure it is connected and in good condition.</li> <li>4. Check condensate line and termination for blockages.</li> <li>5. Check exhaust vent for blockages.</li> <li>6. If the problem persists, replace the main control.</li> </ol>
<b>Er:30</b>	Recirculation (Rt) Sensor Fault	<p>This Error Code will go away when inlet water temperature decreases.</p> <p>If Error happens again:</p> <ol style="list-style-type: none"> <li>1. Check recirculation water temperature sensor. Ensure connections are secure.</li> <li>2. Check sensor resistance. If resistance is zero, replace the sensor.</li> <li>3. If the problem persists, replace the main control.</li> </ol>
<b>Er:31</b>	Water Inlet (In) Sensor Open or Short	<p>This Error Code will go away when inlet water temperature decreases.</p> <p>If Error happens again:</p> <ol style="list-style-type: none"> <li>1. Check inlet water temperature sensor. Ensure connections are secure.</li> <li>2. Check sensor resistance. If resistance is zero, replace the sensor.</li> <li>3. If the problem persists, replace the main control.</li> </ol>
<b>Er:32</b>	Water Outlet (dH) Sensor Open or Short	<p>This Error Code will go away when outlet water temperature decreases.</p> <p>If Error happens again:</p> <ol style="list-style-type: none"> <li>1. Check DHW outlet temperature sensor. Ensure connections are secure.</li> <li>2. Check sensor resistance. If resistance is zero, replace the sensor.</li> <li>3. If the problem persists, replace the main control.</li> </ol>
<b>Er:33</b>	H/X Temperature (OP) Sensor Open or Short	<p>This Error Code will go away when outlet water temperature decreases.</p> <p>If Error happens again:</p> <ol style="list-style-type: none"> <li>1. Check operating temperature sensor. Ensure connections are secure.</li> <li>2. Check sensor resistance. If resistance is zero, replace the sensor.</li> <li>3. If the problem persists, replace the main control.</li> </ol>

Error Code	Error Code Description	Possible Remedies
Er:35	Exhaust (Eh) Sensor Open or Short	This Error Code will go away when exhaust temperature decreases. If Error happens again: 1. Check exhaust temperature sensor. Ensure connections are secure. 2. Check sensor resistance. If resistance is zero, replace the sensor. 3. Check exhaust vent for blockage. 4. If the problem persists, replace the main control.
Er:37	Abnormal Supply Frequency	Supply frequency is too high to operate. This Error Code will go away when supply frequency returns to normal operating range. If Error happens again: 1. Ensure appliance is properly wired to a power source meeting the requirements on the rating plate. 2. If problem persists, replace the main control.
Er:38	Error Appears When Control Stores Data, but Data is not Saved	Press the Power button to clear the Error Code. Replace the main control.
Er:41	Fan Speed too high with flame on	The Error Code will go away unless it occurs five (5) times in ten (10) minutes. Press the Power button to clear the Error Code. If Error happens again: 1. Check the vent connections for blockages. 2. Check the burner assembly. 3. Check fan operation. If fan appears to be operating normally but RPMs are too low or too high, replace the fan. 4. If the problem persists, replace the main control.
Er:42	Jumped Wire Disconnected	Press the Power button to clear the Error Code. If Error happens again: 1. Ensure the jumped wire is properly connected. 2. If the problem persists, replace the main control.
Er:43	Burner overheat switch open	Press the Power button to clear the Error Code. If Error happens again: 1. Check burner overheat switch connections. Ensure connections are secure. 2. Check switch resistance. If resistance is not zero, replace the switch. 3. If the problem persists, replace the main control.
Er:44	Air Pressure Sensor Fault (Wiring Issue)	On Er:45 ONLY: The Error Code will go away unless it occurs five (5) times in ten (10) minutes. Press the Power button to clear the Error Code. 1. Check APS and main controller connections. Ensure all are secure. 2. Check APS hose. Ensure it is connected and in good condition. 3. Check intake and exhaust vent for blockages. 4. Check condensate line and termination for blockages. 5. If the problem persists, replace the main control.
Er:45	Air Pressure Sensor (Intake / Exhaust Blockage)	
Er:46	Water Leak Detection Probe Shorted	Error Code will go away when the water leak detection probe opens. 1. Ensure there is no water inside the bottom of the appliance cabinet. If there is water, find the leak source and address the issue. After the issue has been addressed, clean the bottom of the cabinet and ensure the probes are dry. 2. Check the wiring connection from the probe to the control board. 3. If the problem persists, replace the probe. If problem continues to persist, replace the control. <b>NOTE:</b> When this error occurs, the flow control valve will close the inlet water port until the code is reset.
Er:61	Fan Speed Feedback Signal Abnormal	This Error Code will go away when the condition is remedied. If Error happens again: 1. Check the connections to the fan. Ensure all are secure. 2. If the fan does not rotate during the ignition sequence, check for 8Vac 26.5Vac power at the fan connection. If 8Vac 26.5Vac power is present at the control, replace the fan. If the blower does not have 8Vac 26.5Vac power, check power at the control. If 8Vac 26.5Vac power is not present at the control, replace the control. 3. If the problem persists, replace the main control.
Er:64	Flow Control Valve Operation Fault	Press the Power button to clear the Error Code. If Error happens again: 1. Turn power OFF and ON at the main power switch internal to the water heater. 2. Check wiring connections to supply water valve. Ensure all are secure. 3. Replace supply water valve. 4. If the problem persists, replace the main control.
Er:65	Flow Control Valve Error	
Er:66	Mixing Valve Error	Press the Power button to clear the Error Code. If Error happens again: 1. Turn power OFF and ON at the main power switch internal to the water heater. 2. Check wiring connections to mixing valve. Ensure all are secure. 3. Replace mixing valve. 4. If the problem persists, replace the main control.
Er:68	Mixing Valve Zero Position Fault	

Error Code	Error Code Description	Possible Remedies
<b>Er:70</b>	Register, Ram, Rom, I/O Port, AD Abnormal, Important EPROM Data or Safe Data Abnormal	This Error Code will go away when the condition is remedied. If Error happens again: 1. Turn power OFF and ON at the main power switch internal to the water heater. 2. If the problem persists, replace the main control.
<b>Er:72</b>	Flame Signal Detected before Ignition	This Error Code will go away when the condition is remedied. If Error happens again: 1. Check the water heater cover. Ensure it is secure. Flame detection sensor can detect an external light source. 2. Check flame detection sensor. Ensure connections are secure. Normal operating settings are more than 2.5DC before ignition, less than 2.5DC after ignition. 3. If the problem persists, replace the main control.
<b>Er:76</b>	Poor Communication	This Error Code will go away when the condition is remedied. If Error happens again: 1. Check connections from main control to display panel. 2. If the problem persists, replace the display and/or the main control.
<b>Er:80</b>	Low Water Level Sensor (Low Water Level Detected four [4] Consecutive Times)	This Error Code will go away when the condition is remedied. If Error happens again: 1. Ensure all valves are open to the appliance and there are no leaks. 2. Ensure all air has been purged from the system. 3. Check wiring connections to low water level sensor. Ensure all are secure. 4. Check low water level sensor resistance. If resistance is zero, replace the sensor. 5. If the problem persists, replace the main control.
<b>Er:81</b>	Low Water Level Circuit	This Error Code will go away when the condition is remedied. If Error happens again: 1. Ensure all valves are open to the appliance and there are no leaks. 2. Check wiring connections to low water level sensor. Ensure all are secure. 3. Check low water level sensor resistance. If resistance is zero, replace the sensor. 4. If the problem persists, replace the main control.
<b>Er:85</b>	Freeze Protection (Appliance has detected water temperature below 34°F [1°C])	This Error Code will go away when the freezing condition is remedied. If Error happens again: 1. Ensure boiler is located in a mechanical room protected from freezing conditions. 2. Ensure all valves are open to the boiler and there are no leaks. 3. Check wiring connections to the supply temperature (OP) sensor. Ensure all are secure. 4. Check supply temperature (OP) sensor resistance. If resistance is zero, replace the sensor. 5. If the problem persists, replace the main control.
<b>Er:94</b>	Exhaust (Eh) NTC detects Vent Temperature is Greater than 190°F (87.8°C)	This Error Code will go away when the condition is remedied. If Error happens again: 1. Check if dip switch High Fire setting is ON. Switches 6 and 7 should be OFF for normal operation. 2. Check exhaust temperature sensor. Ensure connections are secure. 3. Check sensor resistance. If resistance is zero, replace the sensor. 4. Check exhaust vent for blockage. 5. If the problem persists, replace the control. 6. If the problem persists, replace the heat exchanger.

**Table 30 - Error Codes and Suggested Corrective Actions**

## **WARNING**

This water heater is equipped with a blocked vent shutoff system. If Error Codes Er:29, Er:41, Er: 42, or Er:94 occur, turn off the gas valve at the manual shutoff. Check the vent terminations for obstructions. If no obstructions are found, reset the water heater by pressing the power button. If the error continues to occur, call a qualified service technician or the gas supplier to check the water heater. Failure to follow these instructions could result in property damage, personal injury, or death.

**B. Error Tree Analysis**  
**1. Flame Detection**

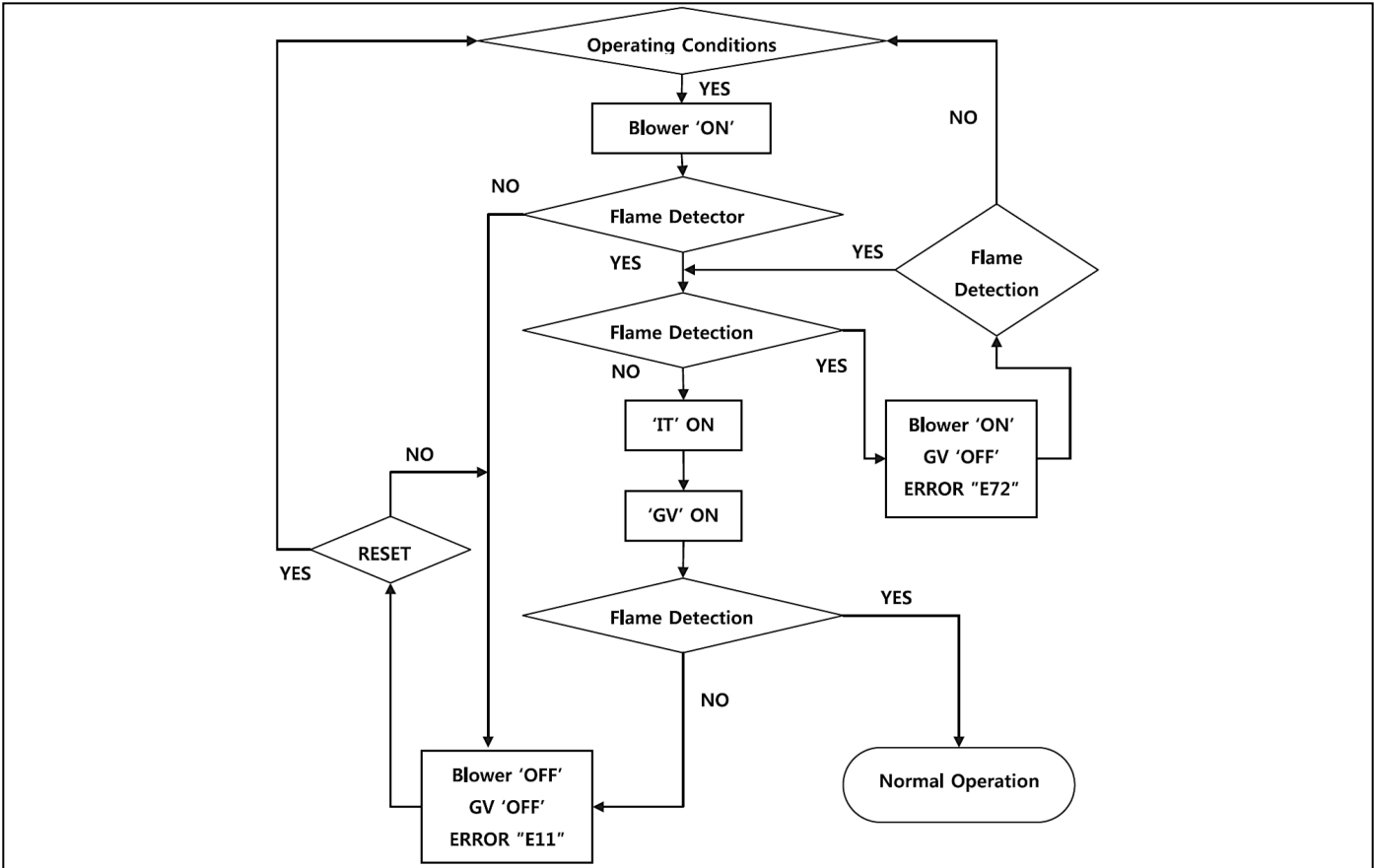

Figure 63 - Flame Detection Error Analysis Tree

**2. Air Pressure Switch Detection**

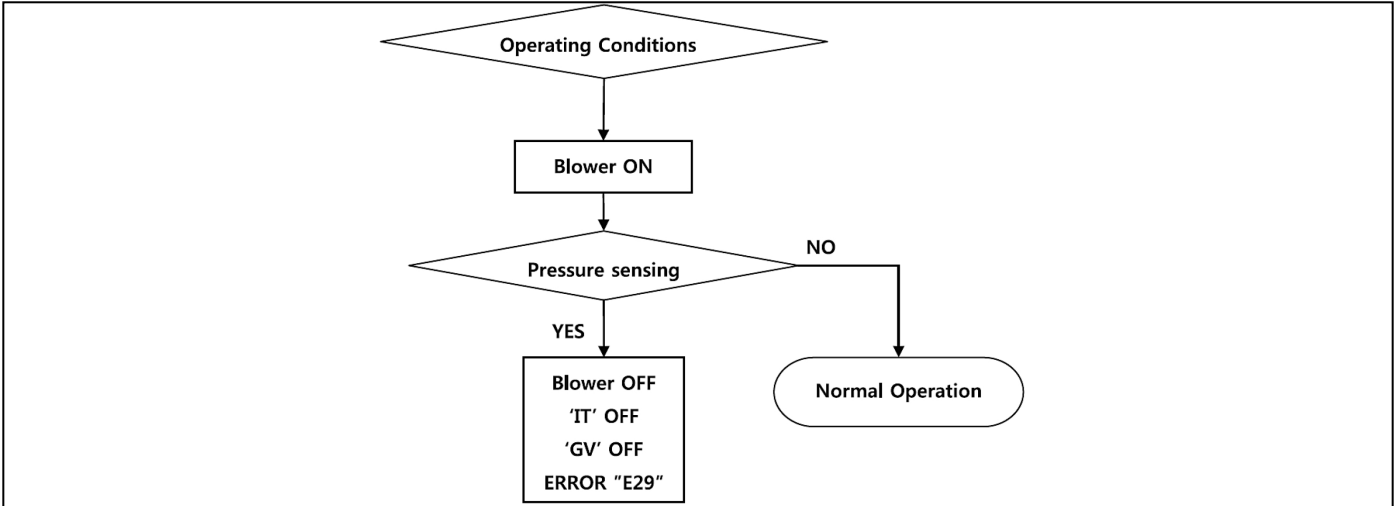

Figure 64 - Air Pressure Switch Analysis Tree

### 3. Recirculation / Inlet / DHW / Operating Temperature / Exhaust Sensors

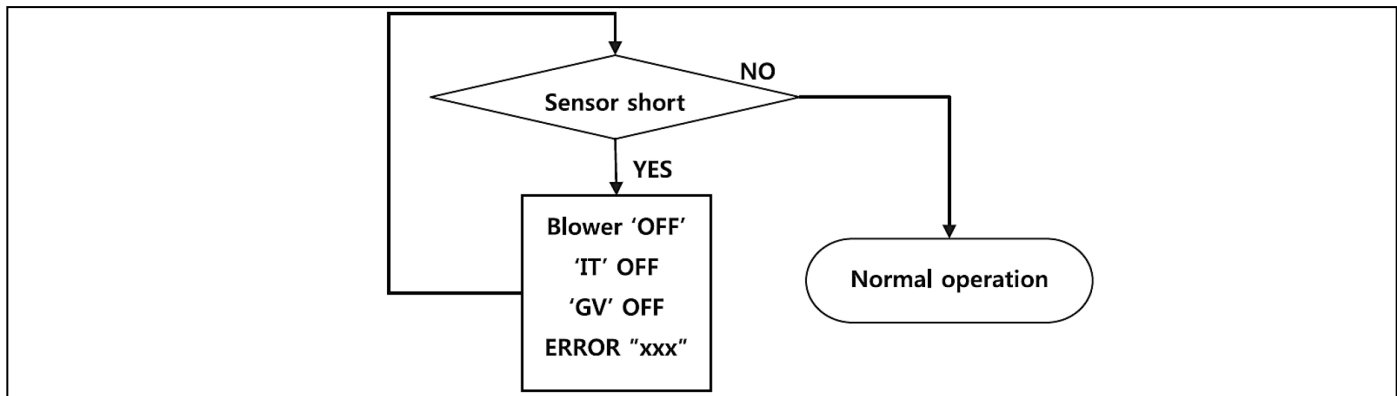

Figure 65 - Recirculation / Inlet / DHW / Operating Temperature Sensors Error Analysis Tree

### C. Suggested Corrective Actions

Problem	Possible Causes	Possible Remedies
No electrical power to the water heater	<ol style="list-style-type: none"> <li>1. Is the plug on the power supply cord unplugged from the electrical outlet?</li> <li>2. Is electrical panel's 10 Amp circuit breaker tripped?</li> <li>3. Is the fuse on the circuit board good?</li> <li>4. Is there a power outage to the home?</li> </ol>	<ol style="list-style-type: none"> <li>1. Reset the plug.</li> <li>2. Reset the circuit breaker.</li> <li>3. If the display panel is blank, unplug the unit or contact an authorized service technician.</li> <li>4. Contact the power company.</li> </ol>
No water available when faucet is opened	<ol style="list-style-type: none"> <li>1. Is the water supply valve shut off at the meter (do cold water faucets work)?</li> <li>2. Is the water supply valve near the unit open?</li> <li>3. Is the water pipe frozen?</li> <li>4. Is an error code flashing on the display panel (leak detected)?</li> </ol>	<ol style="list-style-type: none"> <li>1. Open the closed supply valve.</li> <li>2. Open the water supply valve.</li> <li>3. Turn OFF the unit, close all water valves and the gas valve. Contact an authorized service technician.</li> <li>4. Refer to error code information and contact an authorized service technician.</li> </ol>
Hot water is not available when a faucet is opened	<ol style="list-style-type: none"> <li>1. Does the water heater have power (plugged in)?</li> <li>2. Is the water heater turned ON?</li> <li>3. Is an error code flashing on the display panel?</li> <li>4. Is the gas supply valve open or shut off at the meter (do other gas devices work)?</li> </ol>	<ol style="list-style-type: none"> <li>1. Restore electrical power to the unit.</li> <li>2. Press and hold the Power button to turn the unit ON.</li> <li>3. Refer to the Diagnostic and Error Codes section in this manual.</li> <li>4. Open the gas supply valve.</li> </ol>
The water temperature is not hot enough or turns cold during use	<ol style="list-style-type: none"> <li>1. If recirculation or preheat modes are OFF, is the faucet open enough to draw at least 0.5 gallons (2.2L) per minute through the water heater?</li> <li>2. Is an error code flashing on the display panel?</li> <li>3. Is the outlet water temperature set too low?</li> </ol>	<ol style="list-style-type: none"> <li>1. Activate preheat or internal recirculation modes.</li> <li>2. Open the faucet to allow more water flow.</li> <li>3. Refer to the Diagnostic and Error Codes section in this manual.</li> <li>4. Adjust the outlet water temperature (refer to the procedure in this manual).</li> </ol>
It takes a long time before hot water flows from the faucet	<ol style="list-style-type: none"> <li>1. Is the faucet some distance from the water heater?</li> <li>2. Are recirculation or preheat modes ON?</li> </ol>	<ol style="list-style-type: none"> <li>1. Activate preheat or internal recirculation modes.</li> <li>2. Have recirculation valves and/or plumbing return line(s) installed and program the unit for external recirculation mode.</li> <li>3. Allow time for the cold water already in the pipes to flow from the faucet.</li> </ol>
The water is not hot enough	Is the water temperature set too low?	Adjust the temperature setting.
The water at the faucet is too hot	Is the water temperature set too high?	Adjust the temperature setting.
A fan can be heard even when the unit is not operating	<ol style="list-style-type: none"> <li>1. The fan continues to operate after the burner shuts off to clear the exhaust vent of combustion gases.</li> <li>2. The fan may run to help prevent freezing.</li> </ol>	<ol style="list-style-type: none"> <li>1. This is normal operation – no action is required.</li> <li>2. Protect the water heater from freezing temperatures or shut off and drain the unit.</li> </ol>
White "smoke" can be seen coming out of the exterior exhaust gas vent	Depending on the outside temperature, water vapor can be produced as the exhaust is vented.	This is normal operation – no action is required.

Table 31 - Troubleshooting Chart



**DIAGNOSTICS AND SUGGESTED CORRECTIVE ACTIONS**

The water heater control is able to record information about the water heater's condition at the time of the ten previous faults or errors. This information is available to view in the Installer Mode under the History screen.

The following screens may be displayed when reviewing the water heater history. The table below also includes diagnostic information and possible corrective actions.

Display	Condition	Diagnostic	Possible Corrective Actions
Nothing appears on the display control panel but the fan runs at full speed	Control is not receiving power	Check wiring for short circuit or incorrect wiring	Correct wiring per wiring diagram including connection of transformer to the control.
		Check transformer connection to the control per wiring diagram. Check for 14V output of panel wire.	Push the Power button on the control panel
Nothing appears on the display control panel and no other water heater components are operating	Control is not receiving 120V power	Ensure service switch and/or circuit breaker to water heater is turned ON	Turn on service switch or circuit breaker to power water heater
		Is there 120V at the service switch	Troubleshoot and correct the power supply to the manual switch
		Is the ON/OFF switch inside the water heater cabinet is turned on	Turn ON the manual power switch inside the water heater cabinet
		Check for 120V at the line voltage terminal block located inside the water heater cabinet	Correct wiring inside the water heater cabinet using the wiring diagram in the installation manual
		Inspect the fuse. Replace as necessary	Replace the fuse with the proper part found in the replacement part section of this manual. If fuse blows again, recheck the wiring per diagram
Nothing appears on the display control panel, but the water heater is operating	Occurs when communications is lost from the control to the display	Check for loose connections and proper pin alignment / engagement on the control's plug	Check for continuity on the wire harness from the display to the control. See repair parts section for proper replacement part.
		Cycle power off and on using water heater power switch and check for operation	Replace with new display module. See repair parts section for proper replacement part.
Display repeatedly goes through initialization sequence	Occurs when control does not receive signal from fan	Cycle power off and on using appliance power switch and check for operation	Replace fan

**Table 32 - Diagnostics and Suggested Corrective Actions**

DHW Inlet Temperature (In) Sensor (7850P-015) Exhaust Temperature (Eh) Sensor (7850P-070)		DHW Outlet Temperature (dH) Sensor (7850P-019) HX (OP) Temperature Sensor (7850P-081)	
Temperature (°F)	Resistance (Ω)	Temperature (°F)	Resistance (Ω)
-4	62162	-4	28409
5	48440	5	22152
14	38045	14	17408
23	30107	23	13782
32	23998	32	10990
41	19261	41	8824
50	15562	50	7131
59	12655	59	5800
68	10353	68	4747
77	8520	77	3906
86	7051	86	3233
95	5867	95	2690
104	4908	104	2250
113	4125	113	1891
122	3485	122	1598
131	2957	131	1356
140	2520	140	1155
149	2157	149	989
158	1854	158	850
167	1600	167	733
176	1386	176	635
185	1205	185	552
194	1051	194	482
203	920	203	421
212	808	212	370

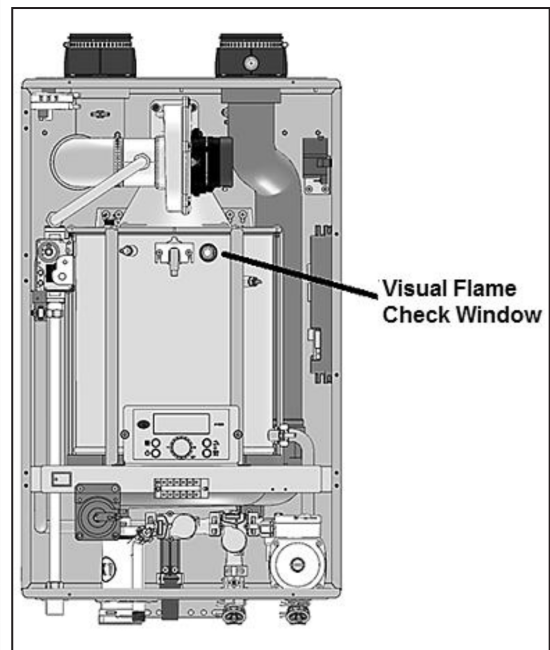

Figure 66 - Flame Sight Glass

Table 33 - Temperature Sensor Resistance

## Part 11 - Installation Checklist

Before Installing	Yes	No
Is there enough space to ensure proper installation?		
Does installation location allow for proper service clearances?		
Are water and gas lines properly sized and set at proper pressures for the installation?		
Is water heater location as near the exhaust vent / intake pipe terminations as possible?		
Have combustible materials been cleared from the installation location?		
Is there a drain close to the water heater?		
Water Piping	Yes	No
Does water heater loop piping meet the minimum sizing requirements listed? <b>NOTE:</b> Smaller piping will cause performance problems.		
Has water chemistry been checked?		
Does water chemistry meet requirements?		
If water chemistry does not meet requirements, have treatment measures been put in place?		
Has the system been cleaned and flushed?		
Install Exhaust Vent and Intake Piping	Yes	No
Has the water heater been vented with the approved materials listed in this manual or to meet local codes?		
Is air supply sufficient for proper water heater operation?		
Is total vent piping length within the maximum vent length restriction listed in this manual?		

<b>Install Exhaust Vent and Intake Piping</b>	<b>Yes</b>	<b>No</b>
Have venting lengths been minimized?		
Are terminations properly spaced from windows, doors, and other intake vents?		
Have all vent terminations been installed at least one foot above exterior grade and one foot above normal snow accumulation level?		
Is vent piping properly supported?		
Has vent piping been checked for leaks?		
Has the exhaust vent line been pitched back to the water heater at a rate of 1/4" per foot?		
Have the exhaust vent and intake pipes been properly installed to the water heater?		
<b>Install Condensate Piping / Tubing and Components</b>	<b>Yes</b>	<b>No</b>
Have all condensate components included with the water heater been installed?		
Is the condensate line piped with the approved materials listed in this manual?		
Has the condensate line been routed to a laundry tub or other drain?		
<b>Install Gas Piping</b>	<b>Yes</b>	<b>No</b>
Is the gas supply line a minimum of 3/4" in diameter?		
Is the gas supply line length and diameter adequate to deliver the required BTUs?		
Has gas supply line pressure been measured?		
Does the gas type match the type indicated on the water heater rating plate?		
Has a union and shut-off valve been installed?		
<b>Relief Valve</b>	<b>Yes</b>	<b>No</b>
Is the Pressure Relief Valve properly installed and discharge line run to open drain?		
Is the discharge line at least 3/4" in diameter and protected from freezing?		
<b>Wiring</b>	<b>Yes</b>	<b>No</b>
Has the power and control been wired per water heater wiring diagram, this manual?		
Have all DIP switches been set on the main water heater board?		
Is the electrical connection polarity within water heater requirements?		
Does the power supply voltage agree with the water heater rating plate? 120V AC?		
<b>Start-Up, Adjust, and Test</b>	<b>Yes</b>	<b>No</b>
Has the water heater been started?		
If necessary, has the water heater gas valve been adjusted?		
Has the installation been customized per installation location requirements?		
Have all customized system parameters been tested?		
Has proper water heater operation been confirmed?		
<b>Burner Flame</b>	<b>Yes</b>	<b>No</b>
Has the burner flame been checked?		
Have combustion values been verified with a meter?		
If the flame does not appear normal, it may need to be cleaned by a qualified service technician. See Figure 66 for flame sight glass window location.		
<b>Final Installation Approvals</b>		
<b>Signed by Technician</b>	<b>Date</b>	

Table 34 - Installation Checklist

## Part 12 - Maintenance

### DANGER

The water heater must be inspected and serviced annually, preferably at the start of the heating season, by a qualified service technician. In addition, the maintenance and care of the water heater as outlined in this manual must be performed by the user/owner to assure maximum efficiency and reliability. Follow the maintenance procedures given throughout this manual. Failure to perform the service and maintenance or follow the directions in this manual could damage the water heater or system components, resulting in substantial property damage, severe personal injury, or death.

#### Check the Surrounding Area

### DANGER

To prevent the potential of substantial property damage, severe personal injury, or death, eliminate all the materials listed in Table 7. from the area surrounding the water heater and the vicinity of the combustion air intake. If contaminates are found:

- Remove products immediately from area.
- If contaminates have been there for an extended period, call a qualified service technician to inspect the water heater for possible damage from acid corrosion.

If products cannot be removed, immediately call a qualified service technician to re-pipe the combustion air intake piping away from the contaminated areas.

#### Combustible/Flammable Materials

Do not store combustible materials, gasoline, or other flammable vapors or liquids near the water heater. If found, remove these materials immediately.

#### Air Contaminates

If allowed to contaminate combustion air, products containing chlorine or fluorine will produce acidic condensate that will cause significant damage to the water heater. Read the list of potential contaminates and areas likely to have these contaminates in Table 7. If any of these contaminates are in the room where the water heater is located, or combustion air is taken from one of the areas listed, the contaminants must be removed immediately or the intake pipe must be relocated to another area.

#### Ensure the Water Heater Cabinet is Closed

Ensure the water heater cabinet is closed. Tighten the two upper and lower screws to secure it. The cabinet must be closed while the water heater is running.

#### Check the Power Source

Make sure the power cord is properly connected. The main power line is connected to the manual switch box inside the water heater.

#### Check the Status of the Control Panel

Observe the Control Panel to ensure the water heater is powered on, and to check for any error codes. Clear any debris from the panel.

#### Check Exhaust Vent and Intake Pipe Terminations

Verify that the water heater exhaust vent and intake pipe terminations are clean and free of obstructions. Remove any debris from the exhaust vent or intake pipe openings. If removing the debris does not allow the water heater to operate correctly, contact your qualified service technician to inspect the water heater and the vent system.

#### Check Exhaust Vent and Intake Piping

Visually inspect the exhaust vent for any signs of blockage, leakage, or deterioration of the piping. Inspect the exhaust vent bracing. Ensure bracing is undamaged and in good condition. Notify a qualified service technician immediately if any problems are found.

### WARNING

Failure to inspect the venting system and have it repaired by a qualified service technician can result in vent system failure, causing severe personal injury or death.

Visually inspect the intake piping for any signs of blockage. Inspect the entire length of the intake pipe to ensure piping is intact and all joints are properly sealed. Inspect the intake pipe bracing. Ensure bracing is undamaged and in good condition. Notify a qualified service technician if any problems are found.

#### Check Pressure Relief Valve

- Visually inspect the primary pressure relief valve and discharge pipe for signs of weeping or leakage.
- If the pressure relief valve often weeps, the expansion tank may not be operating properly. Immediately contact a qualified service technician to inspect the water heater and system.

#### Check the Condensate Drain System

- While the water heater is running, check the discharge end of the condensate drain tubing. Ensure no flue gas is leaking from the condensate drain tubing by holding your fingers near the opening.
- If you notice flue gas leaking from the opening, this indicates a dry condensate drain trap. If problem persists, contact a qualified service technician to inspect the water heater and condensate line and refill the condensate trap.
- If applicable, check the condensate neutralizer and ensure it is full of condensate neutralizing marble chips.

#### Check Primary and Gas Piping

- Remove the water heater cover and perform a gas leak inspection following Operating Instructions, page 2, this manual. If gas odor or leak is detected, follow procedures on page 2. Call a qualified service technician.
- Visually inspect for leaks around the internal water heater water connections and around the heat exchanger. Visually inspect the external system piping, circulators, and system components and fittings. Immediately call a qualified service technician to repair any leaks

### WARNING

Have leaks fixed at once by a qualified service technician. Failure to comply could result in substantial property damage, severe personal injury, or death.

#### Operate Pressure Relief Valve

- Before proceeding, verify that the relief valve outlet has been piped to a safe place of discharge, avoiding any possibility of scalding from hot water.
- Shut power off to the water heater. To avoid scalding, wait for water heater to cool before operating the relief valve.

### WARNING

To avoid water damage or scalding due to relief valve operation, a discharge line must be connected to the valve outlet and directed to a safe place of disposal. This discharge line must be installed by a qualified service technician or heating/plumbing installer in accordance with the water heater installation manual. The discharge line must be terminated so as to eliminate possibility of severe burns or property damage should the valve discharge.

- Lift the relief valve lever. If water flows freely, release the lever and allow the valve to seat. Watch the end of the relief valve discharge pipe to ensure that the valve does not weep

after the line has had time to drain. If the valve weeps, lift the lever again to attempt to clean the valve seat. If the valve does not properly seat and continues to weep, contact a qualified service technician to inspect the valve and system.

- If water does not flow from the valve when you completely lift the lever, the valve or discharge line may be blocked. Immediately shut the water heater down per instructions on page 2 and call a qualified service technician to inspect the valve and system.
- If relief valve seats properly, restore power to the water heater. Observe operation for five minutes and ensure it operates properly.

#### Check the Burner

Clean the exterior of the burner.

#### Cleaning the Cold Water Inlet Filter (Draining the Water Heater)

1. Place a bucket under the appliance to collect the residual water inside the water heater.
2. Press the Power button on the control panel to turn off the electrical power to the water heater. Then turn off the gas valve.
3. Valve off the water heater from the system. If the water heater cannot be isolated from the system, turn off the main water valve. Open the hot water faucets in the system to aid in draining the system.

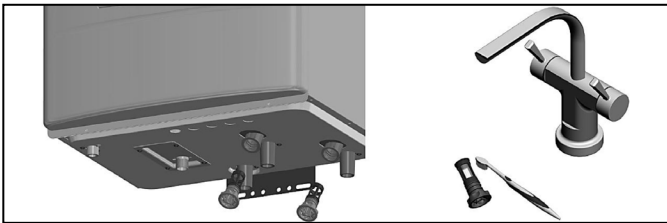

Figure 67 - Draining the Water Heater; Cleaning the Filter

5. Remove the cold water inlet filter. Then clean it with a toothbrush and clean running water. See Figure 67.
6. Reinstall the cold water inlet filter.
7. Restore water service to the water heater by opening the isolation valves, or turning on the main water valve.
8. Turn on the gas valve. Turn on electrical power to the water heater and press the Power button to turn the water heater on.

#### Flushing the Water Heater

Flushing the heat exchanger is a complicated procedure that should only be performed by a qualified service technician.

**NOTE:** Improper maintenance WILL VOID water heater warranty.

1. Disconnect electrical power to the water heater.
2. Close the shutoff valves on both hot water outlet and cold water inlet lines (V1 and V2). See Figure 68.
3. Connect one hose (D1, Figure 68) to the valve (V3) and place the free end in a bucket. Connect one of the hoses (D3) to the circulation pump outlet and the cold water inlet line to valve V4. Connect the other hose (D2) to the circulation pump inlet and place the free end in the bucket.

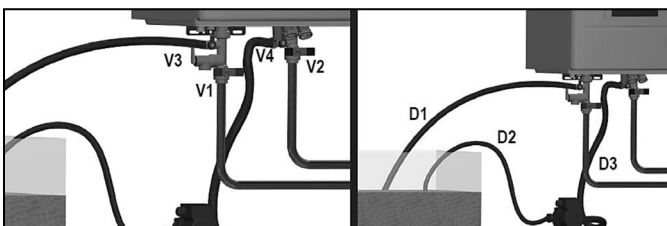

Figure 68 - Flushing the Water Heater

4. Pour tankless water heater cleaning solution into the bucket. Ensure the cleaning solution is approved for potable water systems. Place the drain hose (D1) and hose D2 to the pump inlet in the cleaning solution.
5. Open service valves (V3 and V4) on the hot water outlet and cold water inlet lines.
6. Turn on the pump. Operate the pump and allow the cleaning

solution to circulate through the water heater for at least 1 hour at a rate of 4 gallons per minute. This will remove any possible harmful scale deposits.

7. Rinse the cleaning solution from the water heater as follows:
  - a. Remove the free end of drain hose D1 from the bucket.
  - b. Close service valve V4 and open shutoff valve V2.
  - c. Do not open shutoff valve V1.
  - d. Allow water to flow through the water heater for 5 minutes.
  - e. Close shutoff valve V2.
8. Disconnect all hoses.
9. Remove the cold water inlet filter from the water heater and clean out any residues.
10. Reinsert the filter and ensure the filter cap is securely tightened.
11. Connect electrical power to the water heater.
12. Open a hot water faucet. Run the water heater continuously for five minutes to ensure all cleaning solution is purged from the system. Check for leaks and ensure the water heater is operating properly.

#### Maintenance Report

### CAUTION

In unusually dirty or dusty conditions, care must be taken to keep water heater cabinet door in place at all times. Failure to do so VOIDS WARRANTY!

### WARNING

Allowing the water heater to operate with a dirty combustion chamber will hurt operation. Failure to clean the heat exchanger as needed by the installation location could result in water heater failure, property damage, personal injury, or death. Such product failures ARE NOT covered under warranty.

The combustion chamber insulation in this product contains ceramic fiber material. Ceramic fibers can be converted to cristobalite in very high temperature applications. The International Agency for Research on Cancer (IARC) has concluded, "Crystalline silica inhaled in the form of quartz or cristobalite from occupational sources is carcinogenic to humans (Group 1)."

- Avoid breathing dust and contact with skin and eyes.
- Use a NIOSH certified dust respirator (N95). This type of respirator is based on the OSHA requirements for cristobalite at the time this document was written. Other types of respirators may be needed depending on job site conditions. Current NIOSH recommendations can be found on the NIOSH website: <http://www.cdc.gov/niosh/homepage.html>. NIOSH approved respirators, manufacturers, and phone numbers are also listed on this website.
- Wear long-sleeved, loose fitting clothing, gloves, and eye protection.
- Apply enough water to the combustion chamber lining to prevent dust.
- Wash potentially contaminated clothes separately from other clothing. Rinse clothes washer thoroughly.

NIOSH stated First Aid.

- Eye: Irrigate immediately.
- Breathing: Fresh air.

The water heater requires minimal periodic maintenance under normal conditions. However, in unusually dirty or dusty conditions, periodic vacuuming of the cover to maintain visibility of the display and indicators is recommended.

Periodic maintenance should be performed once a year by a qualified service technician to assure that all the equipment is operating safely and efficiently. The owner should make necessary arrangements with a qualified heating contractor for periodic maintenance of the water heater. Installer must also inform the owner that the lack of proper care and maintenance of the water heater may result in a hazardous condition.

INSPECTION ACTIVITIES		DATE LAST COMPLETED			
PIPING		1st YEAR	2nd YEAR	3rd YEAR	4th YEAR*
Near water heater piping	Check water heater and system piping for any sign of leakage. Leaking pipes could cause property damage. Make sure all piping is properly supported. Flush tankless heat exchanger annually (more in hard water conditions). See User's Information manual for instructions.				
Vent	Check condition of all vent pipes and joints. Ensure all vent piping is properly supported. Check for obstructions exhaust and intake termination points.				
Gas	Check Gas piping, test for leaks and signs of aging. Make sure all pipes are properly supported.				
SYSTEM					
Visual	Do a full visual inspection of all system components.				
Functional	Test all functions of the system (Heat, Safeties)				
Temperatures	Verify safe settings on water heater or Anti-Scald Valve				
Temperatures	Verify programmed temperature settings				
ELECTRICAL					
Connections	Check wire connections. Make sure they are tight.				
Smoke and CO detector	Verify devices are installed and working properly. Change batteries if necessary.				
Circuit Breakers	Check to see that the circuit breaker is clearly labeled. Exercise circuit breaker.				
Switch and Plug	Verify ON/OFF switch and convenience plug are both functional				
CHAMBER/BURNER					
Combustion Chamber	Check burner tube and combustion chamber coils. Clean according to maintenance section of manual. Vacuum combustion chamber.				
Spark Electrode	Clean. Set gap at 1/8".				
CONDENSATE					
Condensate Trap	Clean debris from the condensate trap. Fill with clean water.				
Neutralizer	Check condensate neutralizer. Replace if necessary.				
Condensate hose	Disconnect condensate hose. Clean out dirt and re-install. ( <b>NOTE:</b> Verify the flow of condensate, making sure that the hose is properly connected during final inspection.)				
GAS					
Pressure	Measure incoming gas pressure (3.5" to 14"W.C.)				
Pressure Drop	Measure drop in pressure on light off (no more than 1"W.C.)				
Check gas pipe for leaks	Check piping for leaks. Verify that all are properly supported.				
COMBUSTION					
CO/CO2 Levels	Check CO and CO2 levels in Exhaust. Record at high and low fire.				
SAFETIES					
ECO (Energy Cut Out)	Check continuity on Flue and Water ECO. Replace if corroded.				
FINAL INSPECTION					
Check list	Verify that you have completed entire check list. WARNING: FAILURE TO DO SO COULD RESULT IN SERIOUS INJURY OR DEATH.				
Homeowner	Review what you have done with the homeowner.				
TECH SIGN OFF					

Table 35 - \*Continue annual maintenance beyond the 4<sup>th</sup> year as required.



## Part 13 - Replacement Parts

NUMBER	DESCRIPTION	PART NUMBER	NUMBER	DESCRIPTION	PART NUMBER
B-1	M3 X 6 PH + M/S	7855P-384	B-10	M4 X 12 TH + M/S	7855P-393
B-2	M4 X 8 PH + Self Tapping	7855P-385	B-11	M4 X 14 PH + Self Tapping	7855P-394
B-3	M4 X 8 TH + Self Tapping	7855P-386	B-12	M4 X 15 PW + M/S	7855P-395
B-4	M4 X 8 TH + M/S	7855P-387	B-13	M4 X 20 TH + Self Tapping	7855P-396
B-5	M4 X 10 FH + M/S	7855P-388	B-14	M5 X 14 Flange Bolts + M/S	7855P-397
B-6	M4 X 10 TH + Self Tapping	7855P-389	B-15	M5 X 10 TH+ M/S	7855P-453
B-7	M4 X 10 TH + M/S	7855P-390	B-16	M4 X 9 PH.PW + Self Tapping	7855P-296
B-8	M4 X 10 Flat Head	7855P-391	N-1	M4 Nut	7855P-398
B-9	M4 X 12 PH + M/S	7855P-392	N-2	M5 Nut	7855P-399

**Table 36 - Replacement Bolts and Nuts**

NUMBER	DESCRIPTION	PART NUMBER	NUMBER	DESCRIPTION	PART NUMBER
O-1	Intake and Exhaust Adapter O-Ring	7855P-256	O-7	Gas Valve O-Ring	7855P-076
O-2	Combustion Analyzer Port Plug O-Ring	7855P-334	O-8	P18 O-Ring	7855P-047
O-3	Exhaust Adapter O-Ring (Φ75)	7855P-254	O-9	P15 O-Ring	7855P-044
O-4	Exhaust Temperature Sensor O-Ring	7855P-654	O-10	P20 O-Ring	7855P-282
O-5	Fan O-Ring	7855P-371	O-11	P16 O-Ring	7855P-075
O-6	Air Gas Mixer Gasket	7855P-428	O-12	P22A O-Ring	7850P-262

**Table 37 - Replacement O-Rings and Clips**

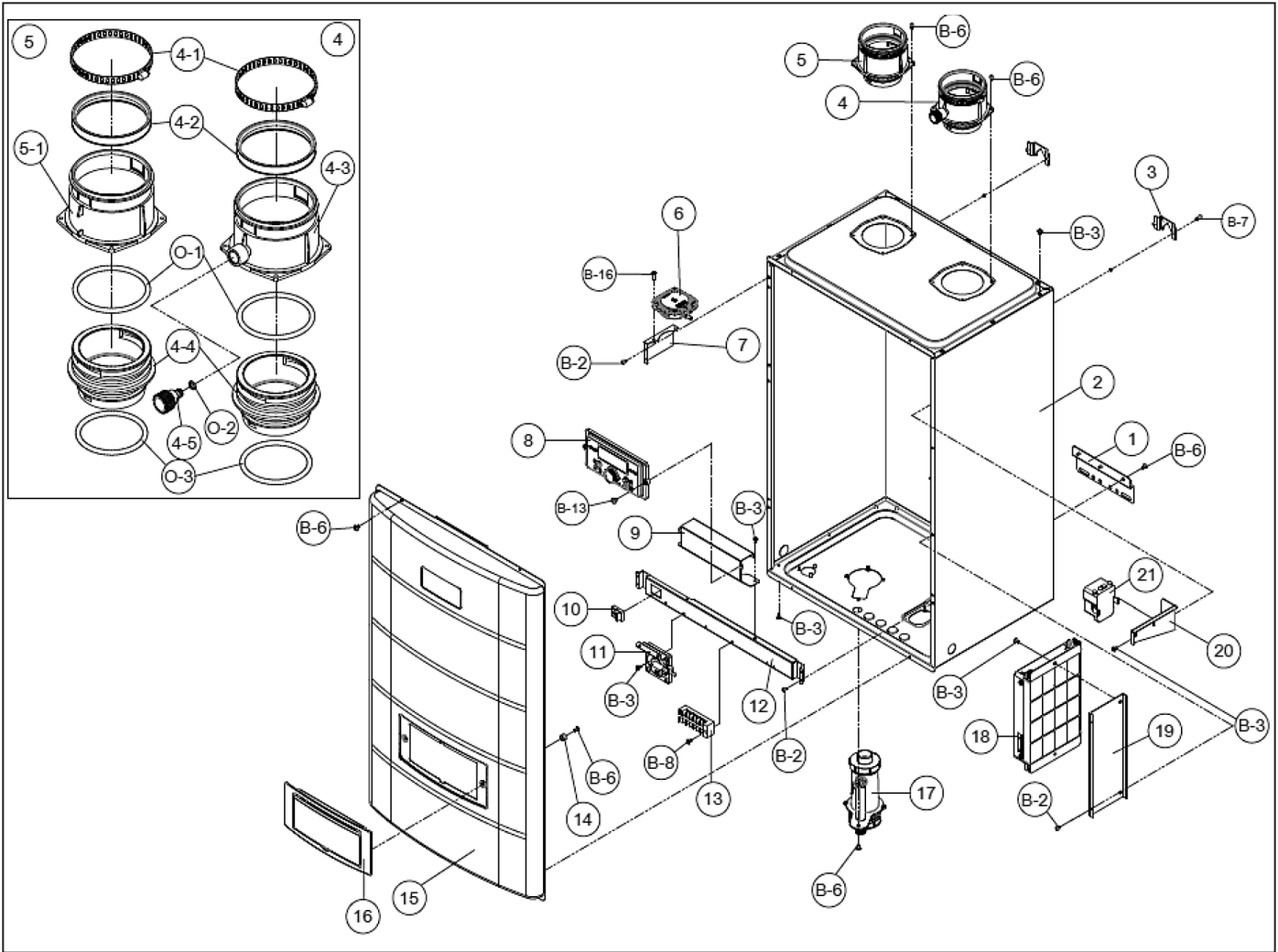

Figure 69 - Cabinet Replacement Parts

NUMBER	DESCRIPTION	PART NUMBER	NUMBER	DESCRIPTION	PART NUMBER	
1	Bottom Wall Mount Bracket	7850P-092	10	Manual Power Switch	7855P-014	
2	Cabinet Assembly - 150 Model	7855P-626	11	Condensate Block APS	7855P-017	
	Cabinet Assembly - 199 Model	7850P-263		12	Power Switch Bracket - 150 Model	7855P-628
3	Top Wall Mount Bracket	7850P-068			Power Switch Bracket - 199 Model	7855P-220
4	Exhaust Duct Assembly	7855P-002	13	Terminal Bracket	7850P-266	
4-1	Exhaust/Intake Duct Clamps (Φ100)	7855P-332	14	Display Panel Cover Plastic Washers	7850P-267	
4-2	Exhaust/Intake Gaskets	7850P-210		15	Front Cover - 150 Model	7855P-629
4-3	Exhaust Duct	7855P-333				Front Cover - 199 Model
4-4	Exhaust Duct Inner Adapter	7855P-004	16	Display Panel Cover	7850P-023	
4-5	Combustion Analyzer Port Plug	7855P-335	17	Condensate Trap Assembly	7855P-605	
5	Air Intake Cap Assembly	7855P-411	18	Control Board - 150 Model	7855P-507	
5-1	Air Intake Cap	7855P-337			Control Board - 199 Model	7855P-506
6	Air Pressure Sensor	7855P-601	19	Control Board Bracket	7850P-269	
7	Air Pressure Sensor Bracket	7850P-264	20	Ignition Transformer Bracket	7850P-270	
8	Display Panel	7855P-600	21	Ignition Transformer	7850P-271	
9	Display Panel Bracket - 150 Model	7855P-627		Wire Harness (Not Shown)	7855P-668	
	Display Panel Bracket - 199 Model	7850P-265				

Table 38 - Cabinet Replacement Parts

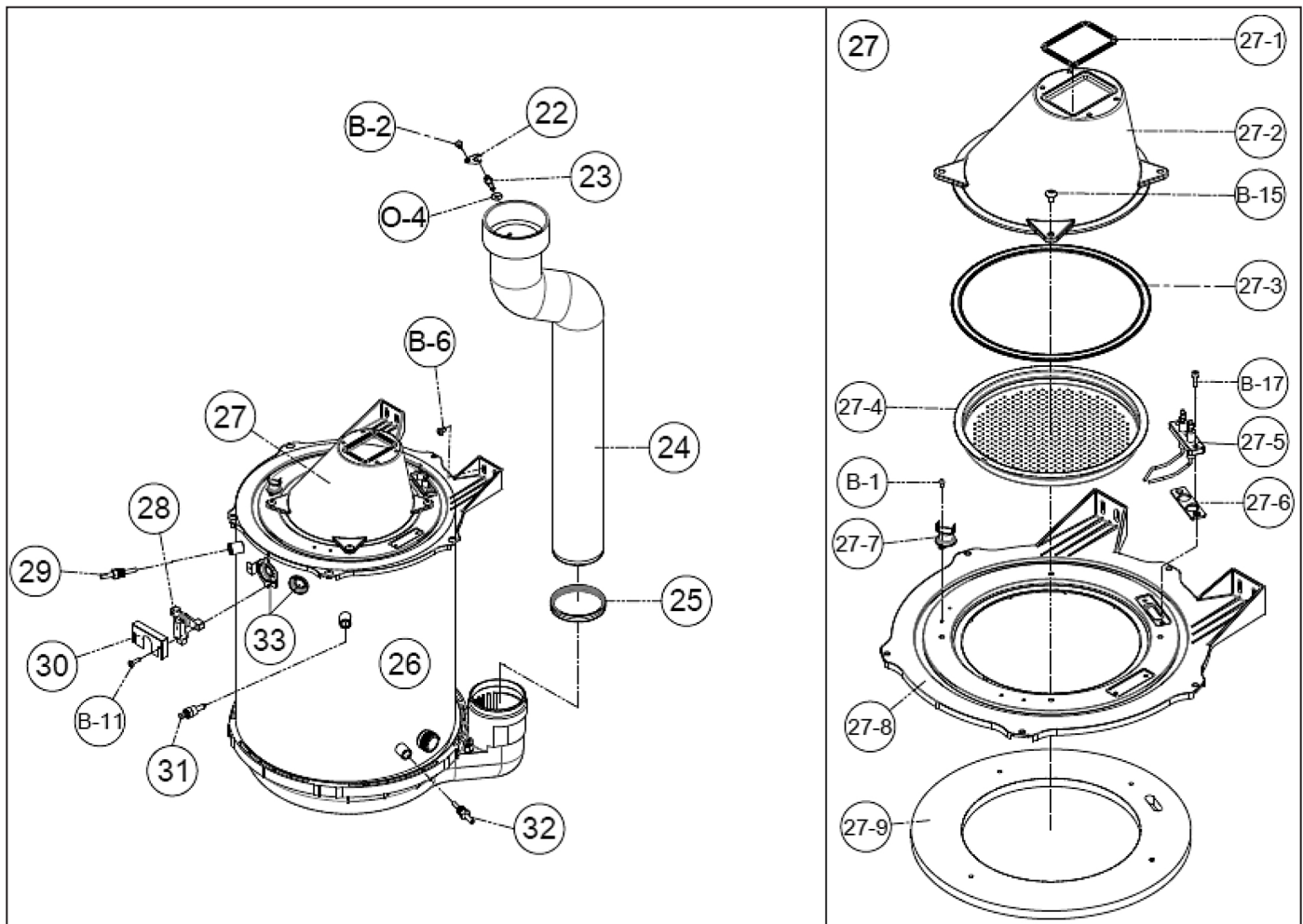
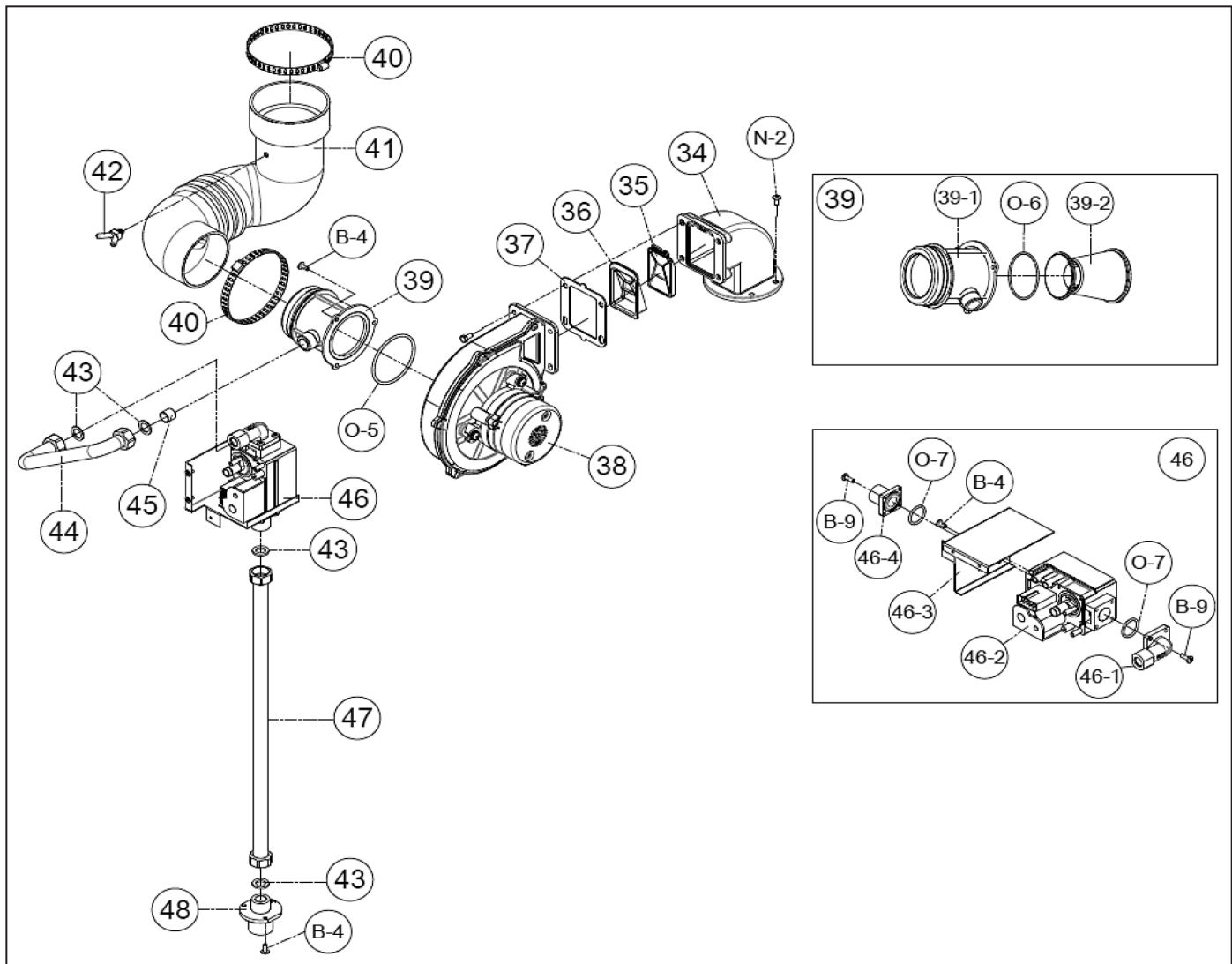

Figure 70 - Heat Exchanger Replacement Parts

NUMBER	DESCRIPTION	PART NUMBER	NUMBER	DESCRIPTION	PART NUMBER
22	Exhaust Temperature Sensor Clip	7855P-349	27-4	Ceramic Fiber Burner - 150 Model	7855P-635
23	Exhaust Temperature (Eh) Sensor	7855P-092		Ceramic Fiber Burner - 199 Model	7855P-420
24	Exhaust Pipe Assembly - 150 Model	7855P-630	27-5	Ignition Rod	7855P-607
	Exhaust Pipe Assembly - 199 Model	7850P-273	27-6	Igniter Gasket	7855P-252
25	Exhaust Pipe Gasket - 150 Model	7855P-351	27-7	Burner Overheat Switch	7855P-066
	Exhaust Pipe Gasket - 199 Model	7855P-418		27-8	Burner Body - 150 Model
26	Heat Exchanger Assembly - 150 Model	7855P-631	27-9		Burner Body - 199 Model
	Heat Exchanger Assembly - 199 Model	7855P-602		Burner Refractory - 150 Model	7855P-636
27	Burner Body Assembly - 150 Model	7855P-632	28	Burner Refractory - 199 Model	7855P-612
	Burner Body Assembly - 199 Model	7855P-619		Flame Sensor	7855P-031
27-1	Burner Body Top Gasket	7855P-426	29	HX Water (OH) Temperature Sensor	7855P-614
27-2	Burner Plate - 150 Model	7855P-633	30	Flame Sensor Cover	7855P-031
	Burner Plate - 199 Model	7855P-606	31	Water Level Detection Sensor	7855P-029
27-3	Burner Gasket - 150 Model	7855P-634	32	Recirculation Water (Rt) Sensor	7855P-615
	Burner Gasket - 199 Model	7855P-419		33	Sight Glass Assembly

Table 39 - Heat Exchanger Replacement Parts



**Figure 71 - Combustion System Replacement Parts**

NUMBER	DESCRIPTION	PART NUMBER	NUMBER	DESCRIPTION	PART NUMBER
34	Burner Inlet Channel (w/ Damper)	7855P-424	44	Gas Pipe (to Mixer) - 150 Model	7855P-638
35	Air Damper - 150 Model	7855P-637		Gas Pipe (to Mixer) - 199 Model	7855P-650
	Air Damper - 199 Model	7855P-618	45	NG Gas Orifice (7.2 mm) - 150 Model	7855P-642
36	Air Damper Guide	7855P-369		LP Gas Orifice (5.5 mm) - 150 Model	7855P-643
37	Fan Outlet Gasket	7855P-425		NG Gas Orifice (8.3 mm) - 199 Model	7855P-610
38	Fan	7855P-025		LP Gas Orifice (6.2 mm) - 199 Model	7855P-435
39	Mixer Assembly - 150 Model	N/A	46	Gas Valve Assembly	7855P-381
	Mixer Assembly - 199 Model		46-1	Gas Valve Outlet Adapter	7855P-232
39-1	Air Gas Mixer (outer part)	7855P-608	46-2	Gas Valve	7855P-034
39-2	Air Gas Mixer (Inner Part) - 150 Model	7855P-648	46-3	Gas Valve Bracket	7855P-436
	Air Gas Mixer (Inner Part) - 199 Model	7855P-609	46-4	Gas Valve Inlet Adapter	7855P-033
40	Air Intake Hose Top Clamp (Φ89)	7855P-429	47	Gas Pipe (to gas valve) - 150 Model	7855P-649
41	Air Intake Hose	7855P-430		Gas Pipe (to gas valve) - 199 Model	7855P-651
42	Barb Fitting 1 X 2	7855P-611	48	Gas Inlet Adapter (3/4")	7855P-382
43	1/2" Gas Pipe Gasket	7855P-221			

**Table 40 - Combustion System Replacement Parts**

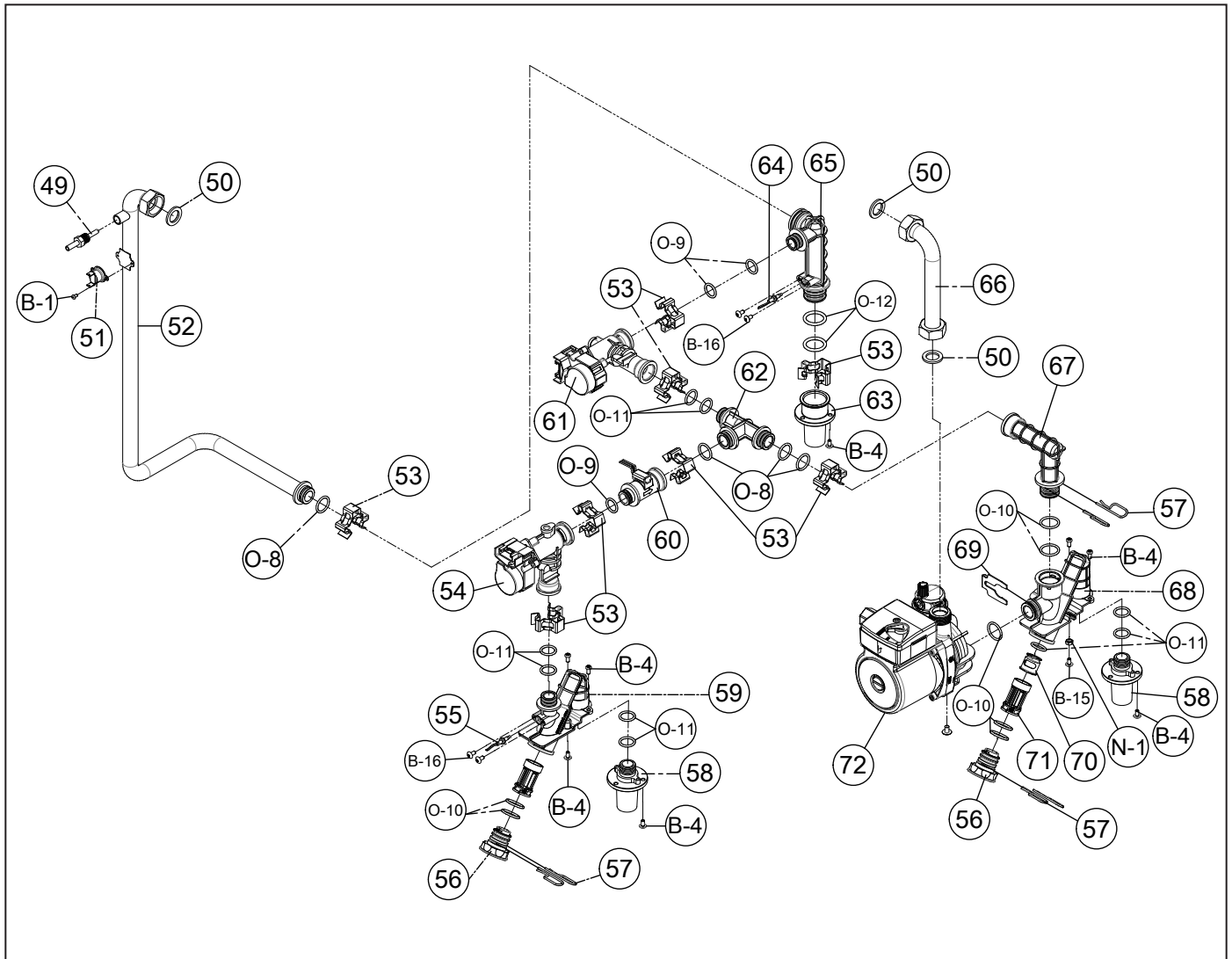

**Figure 72 - Water Side Replacement Parts**

NUMBER	DESCRIPTION	PART NUMBER	NUMBER	DESCRIPTION	PART NUMBER
49	OP Temperature Sensor	7850P-081	62	Mixing Block	7855P-603
50	3/4" Pipe Gasket	7855P-073	63	DHW Outlet Adapter	7855P-225
51	Overheat Switch (Heat Exchanger)	7850P-051	64	DHW Outlet Temperature (dH) Sensor	7855P-094
52	Water Outlet Pipe - 150 Model	7855P-652	65	DHW Inner Block	7855P-251
	Water Outlet Pipe - 199 Model	7850P-276	66	Recirculation Pipe - 150 Model	7855P-644
53	1/2" Pipe Clip	7855P-246		Recirculation Pipe - 199 Model	7850P-277
54	Mixing Valve	7855P-043	67	Pump Block Hybrid	7855P-616
55	DHW Inlet Temperature (In) Sensor	7855P-617	68	Recirculation Block	7855P-604
56	DHW Inlet Block Cap	7855P-283	69	Pump Clip	7850P-238
57	Filter Clips for DHW Block	7855P-284	70	Flow Check	7850P-279
58	DHW Inlet Adapter	7855P-203	71	Domestic Water Filter	7855P-281
59	DHW Inlet Filter Block	7855P-279	72	Recirculation Pump	7850P-237
60	DHW Flow Sensor	7855P-670	73	Water Leak Detection Sensor	7855P-645
61	Mixing Valve	7855P-043			

**Table 41 - Water Side Replacement Parts**



**Limited Warranty for RGH Water Heaters**

HTP warrants this instantaneous water heater and its components to be free from defects in material and workmanship according to the following terms, conditions, and time periods. UNLESS OTHERWISE NOTED THESE WARRANTIES COMMENCE ON THE DATE OF INSTALLATION. This limited warranty is only available to the **original consumer purchaser** (hereinafter "Owner") of this water heater, and is non-transferable.

<b>Residential Use Warranty</b>
Twelve (12) years – Heat Exchanger, Five (5) Years – Components
<b>Commercial Use Warranty</b>
Five (5) years – Heat Exchanger, One (1) Year – Components
<b>Use Definitions</b> - Residential Heating means potable water heating a single family dwelling. This dwelling must be either: a) owned and resided in by the original purchaser; or b) a residential rental property that services a single dwelling in which the original purchaser resides on a permanent basis. Commercial Use refers to all other applications.

**COVERAGE**

- A. During the first year after the original date of installation, HTP warrants that it will repair or replace, at its option, any defective or malfunctioning component of the water heater with a component of equivalent size and current model. Replacement components will be warranted for ninety (90) days.
- B. Should a defect or malfunction result in a leakage of water from the water heater within the above-stated warranty periods due to defective material or workmanship, malfunction, or failure to comply with the above warranty, with such defect or malfunction having been verified by an authorized HTP representative, HTP will replace the defective or malfunctioning water heater with a replacement of the nearest comparable model available at the time of replacement. The replacement water heater will be warranted for the unexpired portion of the applicable warranty period of the original water heater.
- C. In the event of a leakage of water of a replacement water heater due to defective material or workmanship, malfunction, or failure to comply with the above warranty, HTP reserves the right to refund to the Owner the published wholesale price available at the date of manufacture of the original water heater.
- D. If government regulations, industry certification, or similar standards require the replacement water heater or component(s) to have features not found in the defective water heater or component(s), the Owner will be charged the difference in price represented by those required features. If the Owner pays the price difference for those required features and/or to upgrade the size and/or other features available on a new replacement water heater or component(s), the Owner will also receive a complete new limited warranty for that replacement water heater or component(s).
- E. If at the time of a request for service the Owner cannot provide a copy of the original sales receipt or the warranty registration, the warranty period for the water heater shall then be deemed to have commenced thirty (30) days after the date of manufacture of the water heater and NOT the date of installation of the water heater.
- F. This warranty extends only to water heaters utilized in heating applications that have been properly installed by qualified professionals based upon the manufacturer's installation instructions.
- G. It is expressly agreed between HTP and the Owner that repair, replacement, or refund are the exclusive remedies of the Owner.

**OWNER RESPONSIBILITIES**

- The Owner or Qualified Service Technician must:
- 1. Have a relief valve bearing the listing marks of the American Society of Mechanical Engineers (ASME) installed with the water heater assembly in accordance with federal, state, and local codes.
  - 2. Have a vacuum relief valve certified to ANSI Z21.22 - Relief Valves for Hot Water Supply Systems installed with the water heater assembly in accordance with federal, state, and local codes and in installations prone to vacuum related damages.
  - 3. Maintain the water heater in accordance with the maintenance

procedure listed in the manufacturer's provided instructions. Preventive maintenance can help avoid any unnecessary breakdown of the water heater and keep it running at optimum efficiency.

- 4. Maintain all related system components in good operating condition.
- 5. Use the water heater in an open system, or in a closed system with a properly sized and installed thermal expansion tank.
- 6. Use the water heater at water pressures not exceeding the working pressure shown on the rating plate.
- 7. Keep the water heater free of damaging scale deposits.
- 8. Make provisions so if the water heater or any component or connection thereto should leak, the resulting flow of water will not cause damage to the area in which it is installed.

**WARRANTY EXCLUSIONS**

This limited warranty will not cover:

- 1. Any water heater purchased from an unauthorized dealer.
- 2. Any water heater not installed by a qualified service technician, or installations that do not conform to ANSI, CSA, and/or UL standards, as well as any applicable national or local building codes.
- 3. Service trips to teach the Owner how to install, use, maintain, or to bring the water heater installation into compliance with local building codes and regulations.
- 4. The workmanship of any installer. The manufacturer disclaims and does not assume any liability of any nature caused by improper installation, repair, or maintenance.
- 5. Electricity or fuel costs, or increased or unrealized savings for same, for any reason whatsoever.
- 6. Any water damage arising, directly or indirectly, from any defect in the water heater or component part(s) or from its use.
- 7. Any incidental, consequential, special, or contingent damages or expenses arising, directly or indirectly, from any defect in the water heater or the use of the water heater.
- 8. Failure to locate the water heater in an area where leakage of the tank or water line connections and the relief valve will not result in damage to the area adjacent to the water heater or lower floors of the structure, as well as failure to install the water heater in or with a properly sized drain pan routed to an approved drainage location.
- 9. Any failed components of the system not manufactured by HTP as part of the water heater.
- 10. Water heaters repaired or altered without the prior written approval of HTP.
- 11. Damages, malfunctions, or failures resulting from failure to install the water heater in accordance with applicable building codes/ordinances or good plumbing and electrical trade practices.
- 12. Damages, malfunctions, or failures resulting from improper installation, failure to operate the water heater at firing rates or pressures not exceeding those on the rating plate, or failure to operate and maintain the water heater in accordance with the manufacturer's provided instructions.
- 13. Failure to operate the water heater in a an open system, or in a closed system with a properly sized and installed thermal expansion tank.
- 14. Failure or performance problems caused by improper sizing of the water heater, expansion device, piping, or the gas supply line, the venting connection, combustion air openings, electric service voltage, wiring or fusing.
- 15. Damages, malfunctions, or failures caused by improper conversion from natural gas to LP gas or LP gas to natural gas.
- 16. Damages, malfunctions, or failures caused by operating the water heater with modified, altered, or unapproved components, or any component / attachment not supplied by HTP.
- 17. Damages, malfunctions, or failures caused by abuse, accident, fire, flood, freeze, lightning, electrochemical reaction, acts of God and the like.
- 18. Failures (leaks) caused by operating the water heater in a corrosive or contaminated atmosphere.
- 19. Damages, malfunctions, or failures caused by operating an empty or partially empty water heater ("dry firing"), or failures caused by operating the water heater when it is not supplied with water, free to circulate at all times.
- 20. Any damage or failure of the water heater due to the accumulation of solid materials or lime deposits.



21. Any damage or failure resulting from improper water chemistry, or heating anything other than potable water. DEFINITION OF POTABLE WATER - Potable water is defined as drinkable water supplied from utility or well water in compliance with EPA secondary maximum contaminant levels (40 CFR Part 143.3) as shown in the table.

Contaminant	Level
Total Hardness (Residential Use - Below 140°F water temperature)	200 mg/l (12 grains/gallon)
Total Hardness (Commercial Use - Above 140°F water temperature)	120 mg/l (7 grains/gallon)
Aluminum	0.05 to 0.2 mg/l
Chloride	100 mg/l
Color	15 color units
Copper	1.0 mg/l
Corrosivity	Non-corrosive
Fluoride	2.0 mg/l
Foaming Agents	0.5 mg/l
Iron	0.3 mg/l
Manganese	0.05 mg/l
Odor	3 threshold odor number
pH	6.5 – 8.5
Silver	0.1 mg/l
Sulfate	250 mg/l
Total Dissolved Solids (TDS)	500 mg/l
Zinc	5 mg/l
Dissolved Carbon Dioxide (CO <sub>2</sub> )	15 mg/l or ppm

22. Any damages, malfunctions, or failures resulting from the use of dielectric unions.

23. Water heaters replaced for cosmetic reasons.

24. Components of the water heater that are not defective, but must be replaced during the warranty period as a result of reasonable wear and tear.

25. Components of the water heater that are subject to warranties, if any, given by their manufacturers; HTP does not adopt these warranties.

26. Damages, malfunctions, or failures resulting from the use of any attachment(s) not supplied by HTP.

27. Water heaters installed outside the fifty states (and the District of Columbia) of the United States of America and Canada.

28. Water heaters moved from the original installation location.

29. Water heaters that have had their rating labels removed.

#### PROCEDURES FOR WARRANTY SERVICE REQUESTS

Any claim for warranty assistance must be made immediately upon finding the issue. First, please consult the HTP Warranty Wizard (<http://www.htproducts.com/Warranty-Wizard.html>) to check warranty eligibility. You may also contact HTP Technical Support at 1-800-323-9651 for questions or assistance. Warranty coverage requires review and approval of the issue with HTP Technical Support or through the Warranty Wizard prior to a full unit replacement. Any claim for warranty reimbursement will be rejected if prior approval from HTP is not obtained in advance of a full unit replacement. Final determination will be made as part of the warranty claim process.

**When submitting a warranty claim the following items are required:**

1. **Proof of purchase or installation of the product** – Typically a copy of the invoice from the installing contractor, the receipt of the purchase of the product, or an original certificate of occupancy for a new home.
2. **Clear pictures (or video) of the following:**
  - a. Serial number tag (sticker)
  - b. The product
  - c. The product issue / failure whenever possible

d. A picture of the piping near the product

e. For gas fired products, a picture of the venting, including how it exits the building

All claims will be reviewed by HTP within three (3) business days. If additional information is required and requested by the HTP Claims Department you will have thirty (30) days to provide it. When all requested information is provided HTP will respond within three (3) business days. The claim will be automatically closed if requested information is not provided within thirty (30) days. Claims will not be reopened without HTP Warranty Supervisor approval.

During the claims process a product that must be replaced will be given a designation of either a) field scrap, or b) return to HTP. If the product must be returned to HTP, the returned product must arrive at HTP within thirty (30) days of the date of our request to return the product. After receipt of the returned product HTP may require as many as thirty (30) additional days for product testing. **NOTE: Any components or heaters returned to HTP for warranty analysis will become the property of HTP and will not be returned, even if credit is denied.**

If you have questions about the coverage of this warranty, please contact HTP at the following address or phone number: HTP, 272 Duchaine Blvd., New Bedford, MA, 02745, Attention: Warranty Service Department, 1(800) 323-9651.

#### SERVICE, LABOR AND SHIPPING COSTS

Except when specifically prohibited by the applicable state law, the Owner, and not the Manufacturer, shall be liable for and shall pay for all charges for labor or other expenses incurred in the removal, repair, or replacement of the water heater or any component part(s) claimed to be defective or any expense incurred to remedy any defect in the product. Such charges include, but are not necessarily limited to:

1. All freight, shipping, handling, and delivery costs of forwarding a new water heater or replacement part(s) to the owner.
2. All costs necessary or incidental in removing the defective water heater or component part(s) and installing a new water heater or replacement part(s).
3. All administrative fees incurred by the Owner, as well as material required to complete, and/or permits required for, installation of a new water heater or replacement part(s), and
4. All costs necessary or incidental in returning the defective water heater or component part(s) to a location designated by the manufacturer.

#### LIMITATIONS OF YOUR HTP WARRANTY AND REMEDIES

**THE FOREGOING WARRANTIES ARE EXCLUSIVE AND ARE GIVEN AND ACCEPTED TO THE FURTHEST EXTENT UNDER APPLICABLE LAW IN LIEU OF ANY AND ALL OTHER WARRANTIES, EXPRESS OR IMPLIED, INCLUDING WITHOUT LIMITATION THE IMPLIED WARRANTIES OF MERCHANTABILITY AND FITNESS FOR A PARTICULAR PURPOSE AND ANY OBLIGATION, LIABILITY, RIGHT, CLAIM OR REMEDY IN CONTRACT OR TORT, WHETHER OR NOT ARISING FROM HTP'S NEGLIGENCE, ACTUAL OR IMPUTED. THE REMEDIES OF THE OWNER SHALL BE LIMITED TO THOSE PROVIDED HEREIN TO THE EXCLUSION OF ANY OTHER REMEDIES INCLUDING WITHOUT LIMITATION, INCIDENTAL OR CONSEQUENTIAL DAMAGES, SAID INCIDENTAL AND CONSEQUENTIAL DAMAGES INCLUDING, BUT NOT LIMITED TO, PROPERTY DAMAGE, LOST PROFIT OR DAMAGES ALLEGED TO HAVE BEEN CAUSED BY ANY FAILURE OF HTP TO MEET ANY OBLIGATION UNDER THIS AGREEMENT INCLUDING THE OBLIGATION TO REPAIR AND REPLACE SET FORTH ABOVE. NO AGREEMENT VARYING OR EXTENDING THE FOREGOING WARRANTIES, REMEDIES OR THIS LIMITATION WILL BE BINDING UPON HTP. UNLESS IN WRITING AND SIGNED BY A DULY AUTHORIZED OFFICER OF HTP. THE WARRANTIES STATED HEREIN ARE NOT TRANSFERABLE AND SHALL BE FOR THE BENEFIT OF THE ORIGINAL OWNER ONLY.**

#### NO OTHER WARRANTIES

This warranty gives the Owner specific legal rights. The Owner may also have other rights that vary from state to state. Some states do not allow the exclusion or limitation of incidental or consequential damages so this limitation or exclusion may not apply to the Owner.

These are the only written warranties applicable to this water heater manufactured and sold by HTP. HTP neither assumes nor authorizes anyone to assume for it any other obligation or liability in connection with said water heaters.

HTP reserves the right to change specifications or discontinue models without notice.



<b>Customer Installation Record Form</b>	
The following form should be completed by the installer for you to keep as a record of the installation in case of a warranty claim. After reading the important notes at the bottom of the page, please also sign this document.	
Customer's Name	
Date of Installation	
Installation Address	
Product Name / Serial Number(s)	
Comments	
Installer's Code / Name	
Installers Phone Number	
Signed by Installer	
Signed by Customer	
Installation Notes	

**IMPORTANT**

Customer: Please only sign after the installer has fully reviewed the installation, safety, proper operation, and maintenance of the system. If the system has any problems please call the installer. If you are unable to make contact, please call your sales representative.  
 Distributor / Dealer: Please insert contact details.